

# LIVING now



TRADITIONAL  
CONTROL



CONTROL WITH  
SMARTPHONE



VOICE  
COMMAND



PLANNING  
PROGRAMMED

# CONTENTS

## DESIGN

DESIGN INNOVATION	6
NEW DIGITAL CONTROLS WITH LIVING NOW FINISH	8
FINISHING	10

## THE SOLUTION FOR ALL SYSTEM REQUIREMENT 18

### LIVING NOW IoT

SMART ELECTRICAL SYSTEM	20
HOME+CONTROL APP	24
MANAGE THE HOME ALSO WITH THE VOICE	26
SMART DEVICES RANGE	28
INSTALLATION	30
THE NEW CONNECTED THERMOSTAT SMARTHER	32

### LIVING NOW MYHOME\_UP

INSTALL THE MYHOME_UP SYSTEM USING THE LIVING NOW RANGE	34
NEW DIGITAL AND VOICE CONTROL	36
INSTALLATION OF DIGITAL CONTROLS	42

## ALWAYS PERFECT INSTALLATION 44

## AN INTERNATIONAL STANDARD 48

## CATALOGUE 50



# LIVING now



## Forever an icon, today Smart as well.

Living Now is the new Living generation. A timeless icon which combines the linearity of a unique design with the simplicity of Smart technology. All this without changing usual wiring procedures because Living Now is always installed in the traditional way, guaranteeing a perfect installation.



Traditional control



Control with smartphone



Voice command



Planning programmed

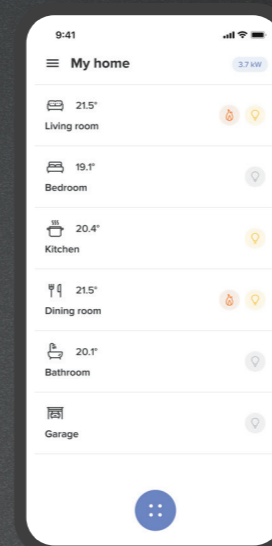

- **Innovative design:** revisited relationship between cover plate and functions.
- **Smart:** the first intrinsically connected wiring devices range!
- The best technical solutions for a **perfect installation.**

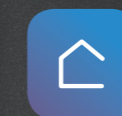
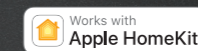

App Home + Control





# DESIGN INNOVATION

PERFECT PLANARITY AND  
ELEGANT DETAILS



Living Now, has won this prestigious international award confirming Legrand's ability to combine technology and design.



The international jury at the XXVI Compasso d'Oro ADI Award 2020, granted Living Now an Honourable Mention. The Compasso d'Oro ADI Award is the oldest and most authoritative international design award.

**FULL TOUCH CONTROLS**  
The light can be switched on or off by pressing any point of the surface of the keys. After being pressed, the keys return to their original position, perfectly aligned.

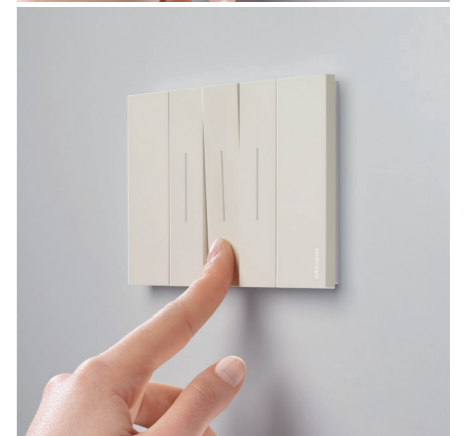

**MORE SPACE FOR FUNCTIONS**  
Unique shape with space increased for functions.



# NEW DIGITAL CONTROLS WITH LIVING NOW FINISH

Living Now series digital controls are now part of the MyHOME\_Up home automation range. A mix of incomparable innovation and simplicity, ready to be discovered, heard and touched.





# DEVICE FINISHING

WHITE



SAND



BLACK



## 3 COLOURS FOR THE DEVICES

The devices feature an aesthetic component, the covers, available in three different colours: white, sand and black. Satin finish surface: for a pleasant feel.

## COMBINATION WITH THE COVER PLATES

The Living Now cover plate range includes 16 finishes, purposely selected for use with the device covers, and made of different materials: techno polymer, metal and wood.



## COORDINATION OF APPEARANCE OF THE MYHOME\_UP DIGITAL CONTROLS

MyHOME\_Up digital controls do not require the use of cover plates and are available in white, sand and black.





# COVER PLATE FINISHING



**ICE cover plate**  
Material: techno polymer  
Code: ...DW



The zamak and wood finishes are obtained using non-mass production procedures. The individual differences among the various cover plates are therefore a distinguishing valuable element.



**WHITE cover plate**  
Material: techno polymer  
Code: ...KW



**GOLD cover plate**  
Material: zamak  
Code: ...ZW



**MOON COVER PLATE**  
Material: zamak  
Code: ...NW



**SKY cover plate**  
Material: techno polymer  
Code: ...DA



**PIXEL cover plate**  
Material: techno polymer  
- pixel effect  
Code: ...MW



# COVER PLATE FINISHING



**OAK cover plate**  
Material: wood  
Code: ...LM



The zamak and wood finishes are obtained using non-mass production procedures. The individual differences among the various cover plates are therefore a distinguishing valuable element.



**SAND cover plate**  
Material: techno polymer  
Code: ...KM



**COPPER cover plate**  
Material: zamak  
Code: ...ZM



**AURA cover plate**  
Material: techno polymer  
Code: ...DM



**OPTIC cover plate**  
Material: techno polymer  
- pixel effect  
Code: ...MM



# COVER PLATE FINISHING



**STEEL cover plate**  
Material: zamak  
Code: ...ZG



The zamak and wood finishes are obtained using non-mass production procedures. The individual differences among the various cover plates are therefore a distinguishing valuable element.



**BLACK cover plate**  
Material: techno polymer  
Code: ...KG



**SPACE cover plate**  
Material: zamak  
Code: ...NG



**WALNUT cover plate**  
Material: wood  
Code: ...LG



**NIGHT cover plate**  
Material: techno polymer  
Code: ...DG



THE RIGHT SOLUTION FOR ALL NEEDS

# SMART ELECTRICAL SYSTEM

Living Now IoT

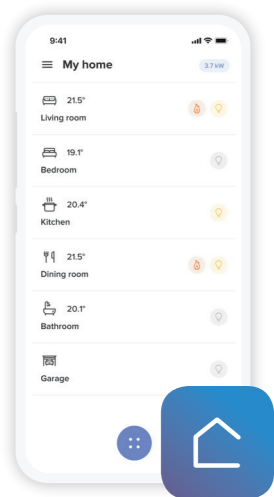
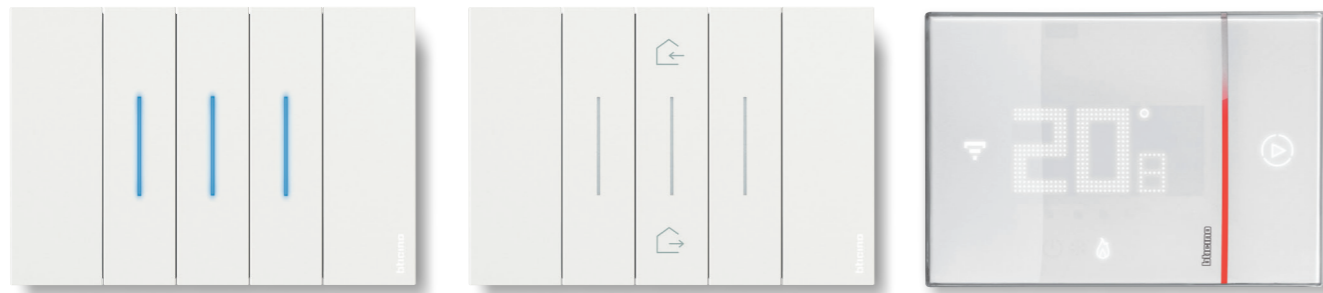

App HOME + CONTROL

## INSTALLATION WITH TRADITIONAL WIRING

Install a traditional electric system and add the SMART functions connected to the home Wi-Fi network, controlled using the HOME + CONTROL App.

### FUNCTIONS

- Lights
- Shutters
- Sockets
- Temperature control
- Scenario control
- Consumption display
- Load anti-blackout control
- Planning programmed

### CHOOSE HOW TO CONTROL IT



LIVING  
now

# HOME AUTOMATION SYSTEM

Living Now MyHOME\_Up

alex built-in

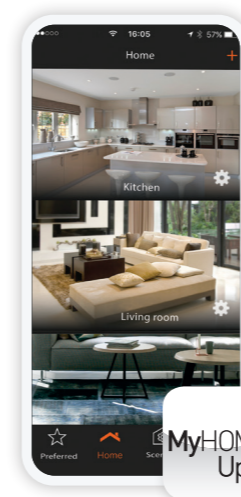

App MyHOME\_Up

## INSTALLATION WITH BUS

Create a BUS integrated system manageable from the MyHOME\_UP App, using your voice or the Touch Screen controls.

### FUNCTIONS

- Lights
- Shutters
- Sockets
- Temperature control
- Scenario control
- Consumption display
- Load anti-blackout control
- Video door entry system
- NUVO sound diffusion system
- Integration with other brand.

### CHOOSE HOW TO CONTROL IT





# SMART ELECTRICAL SYSTEM

Check your home just like your e-mail or your bank account. Starting from today, you will have all this at your fingertips, in full safety and easily.

App  
HOME + CONTROL

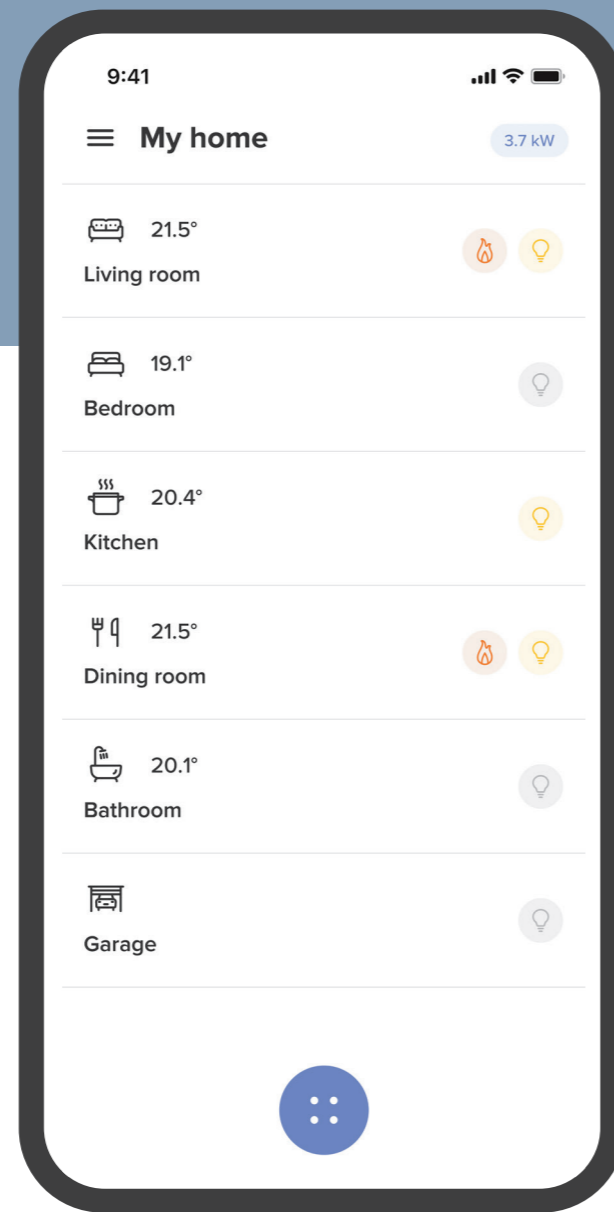

## GENERAL CONTROL

With one single click, a general control will allow you to switch off all the lights and lower all the shutters when you leave your home, or to activate your favourite scenario.



## CONTROL WITH SMARTPHONE

From your smartphone, you will be able to view and check the status of lights, shutters and connected power sockets from anywhere.



## VOICE COMMAND

You can control your system with your voice thanks to your favourite voice assistant.

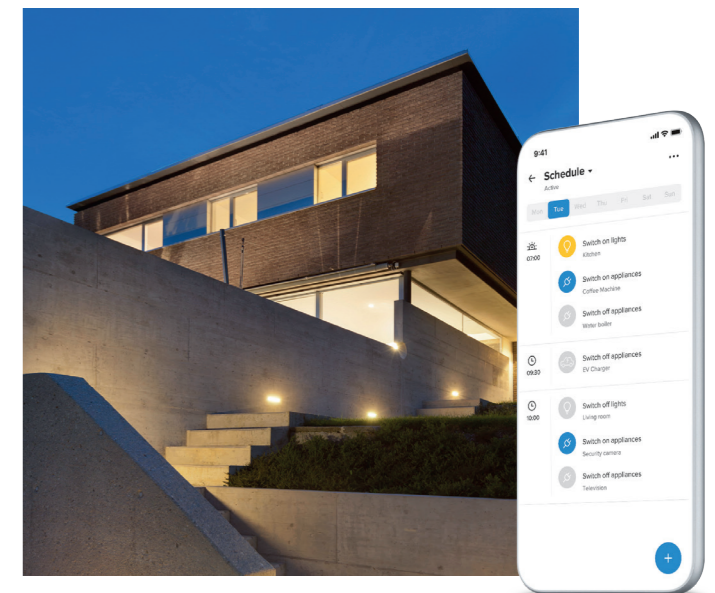

## PLANNED PROGRAMMING

Program the activation of lights, shutters and loads connected to sockets based on your needs. Some examples:

- automatically switch on the garden lights at sunset and switch them off at sunrise;
- switch on some lights and activate some shutters to simulate the presence of someone in the house when on holidays.



# Smart electric system

## MANAGEMENT OF THE TEMPERATURE

Remotely check and manage the temperature inside your home using your smartphone by installing the connected thermostat Smarther IoT.



## LOAD CONTROL TO AVOID BLACKOUTS (\*)

In overload conditions, the system automatically disconnects the least important load to avoid tripping of the meter (blackout).



## ENERGY CONSUMPTION CONTROL

Use your smartphone to check the electricity consumption of your appliances daily, monthly and yearly.



## LIGHTING AT THE DESIRED LEVEL

Adjust the light level for optimum personal comfort. You can do that from the connected Dimmer, the associated wireless controls and the Smartphone, using the Home+Control App.



## WIRELESS CONTROL

You can add wireless controls (lights, shutters and sockets), or reposition them at any time depending on your needs.



## ALARM NOTIFICATIONS

You can receive warning notifications on your smartphone.



# HOME + CONTROL

One single App, many connected advantages



Home+Control is the App that makes it simple to supervise all the Living Now Smart system functions using iOS and Android mobile devices, inside and outside the home.

The Homepage shows all the system information.



## WHAT YOUR CUSTOMER CAN DO:

1. Activate and customise **8 scenarios** (4 preconfigured scenarios, coming in, going out, day, night and 4 scenarios customisable by the user);
2. **Display and check the status of lights, shutters, loads connected to sockets and the room temperature;**
3. **Use the Smarther timer thermostat** simply and intuitively;
4. **Check the total home consumptions.**
5. **Receive notifications** on the load and system status;
6. **Define the load priority** for black-out prevention.

## HOME + CONTROL CONFIGURATION IS EASY, BOTH FOR YOU AND YOUR CUSTOMER.

You simply have to download the App from the Apple or Google store, and follow the guided procedure.

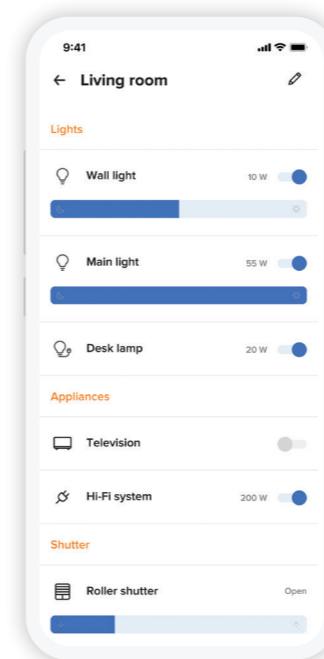

Lights, shutters and generic loads activations

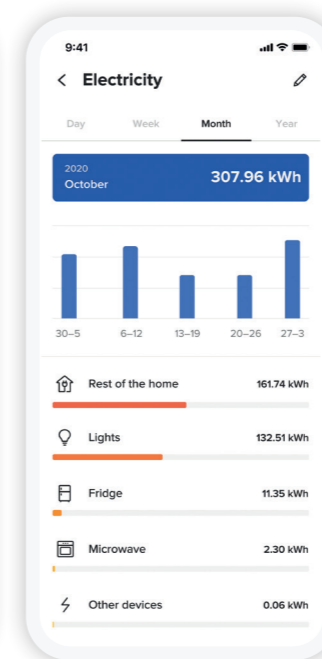

Consumption display

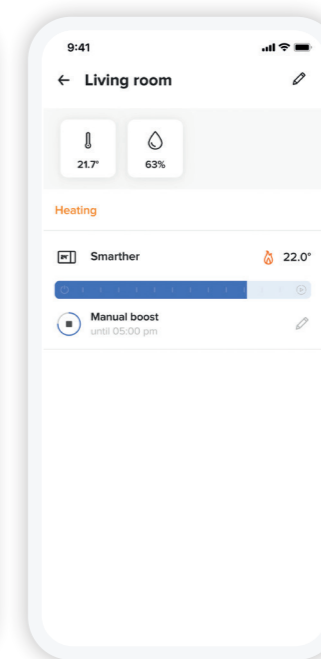

Management of the temperature

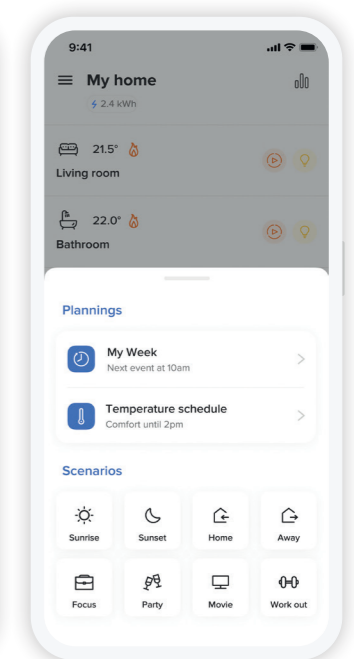

Scenario management





# YOUR CUSTOMERS CAN ALSO MANAGE THEIR HOME WITH THEIR VOICE

With Living Now IoT, your customer will be able to control the system using Apple, Google and Amazon voice assistants. An extremely useful features, also for those with mobility problems.

«OK Google, set Kitchen light to 100%»

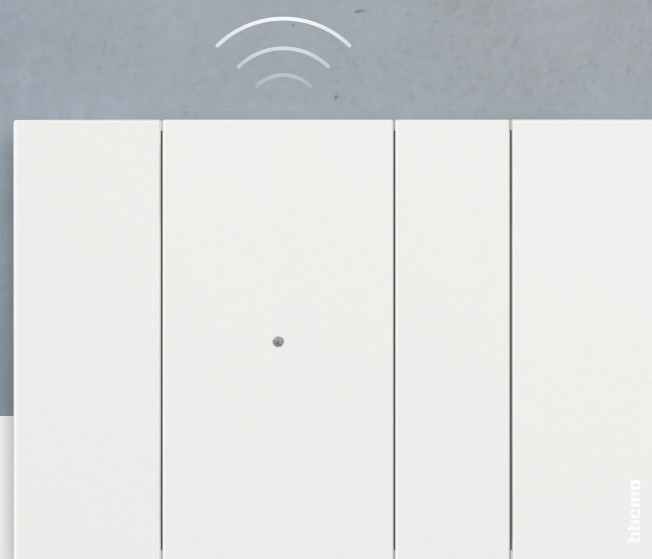
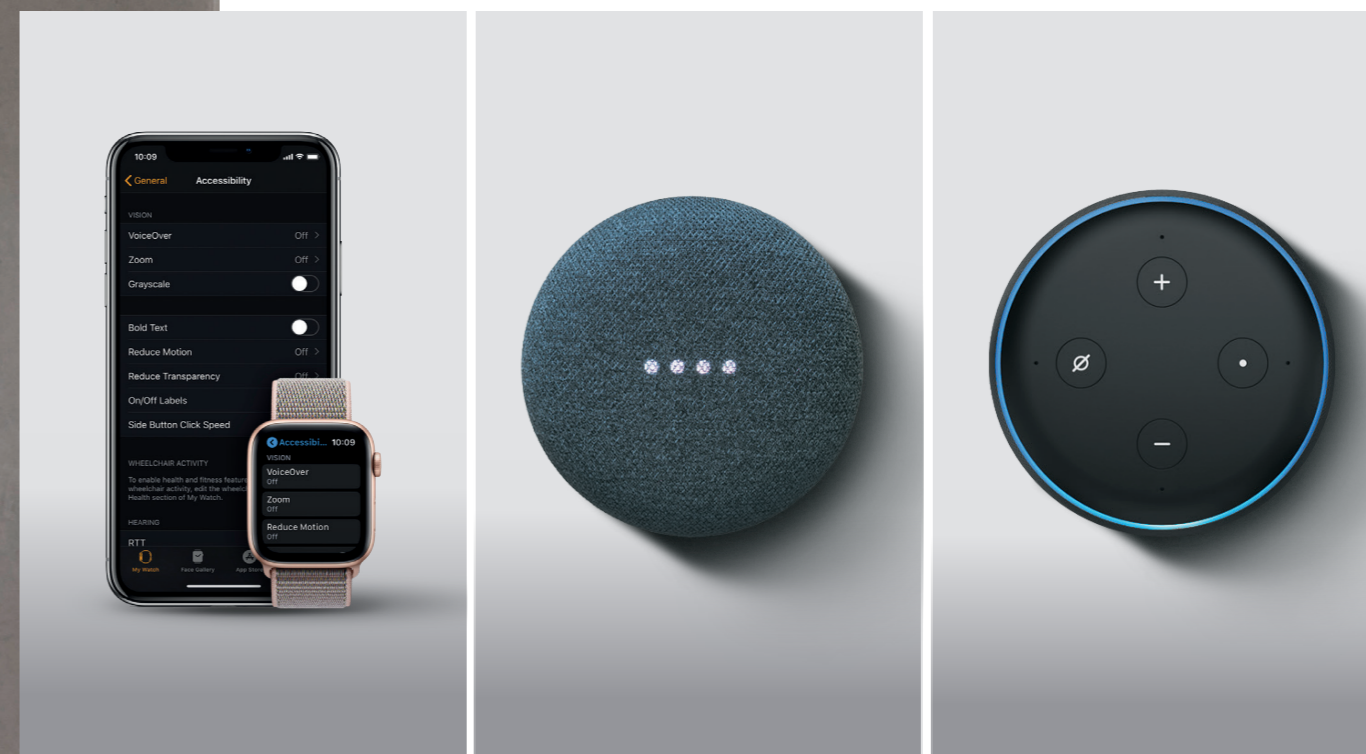







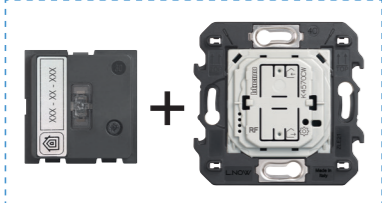

Gateway for the connection of the system to the Internet through the Home Wi-Fi network.

“SIRI, switch the bedroom light on”,  
“OK Google, switch all the home lights off”,  
“ALEXA, set temperature to 20 degrees”.



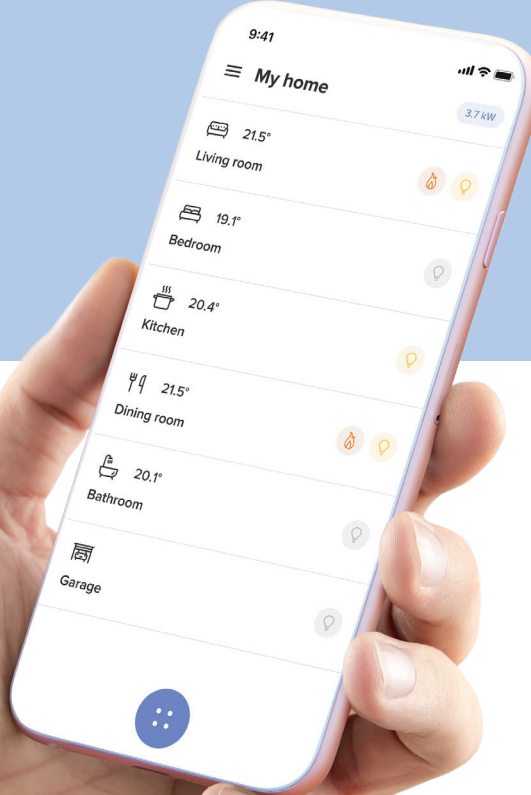
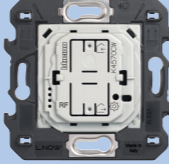
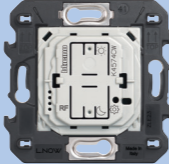
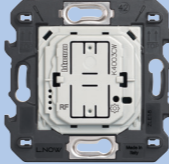
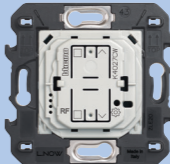

Smart electrical system a simple, rational range of connected devices, both wired and wireless.

REMOTE CONNECTION	SCENARIOS	LIGHTS	SHUTTERS	ENERGY AND CONSUMPTION MANAGEMENT
<p><b>CONNECTED DEVICES (230V A.C.)</b></p>  <p><b>Item K4500C</b> Gateway with Home/Away wireless switch</p>		 <p><b>Item K4003C</b> Connected two-way switch</p>  <p><b>Item K4411CM2</b> Connected switch/dimmer</p>  <p><b>Item 3584C</b> Connected light relay 1,3 A</p>	 <p><b>Item K4027C</b> Connected shutter control</p>	 <p><b>Item K4531C</b> Connected module for socket -16 A</p>
<p><b>BATTERY WIRELESS CONTROLS</b></p> 	 <p><b>Item K4570CW</b> Home/Away wireless switch</p>  <p><b>Item K4574CW</b> Night&amp;Day scenario control</p>	 <p><b>Item K4003CW</b> Light control</p>	 <p><b>Item K4027CW</b> Shutter control</p>	<p>Connected thermostat <b>Item XW8002</b> <b>Item XW8002W</b> <b>Item XM8002</b> <b>Item XG8002</b></p> 

See catalogue for detailed descriptions, availability and full range of products.



# IT IS INSTALLED JUST LIKE A TRADITIONAL ELECTRIC SYSTEM

## 1. DEVICES ARE INSTALLED AND WIRED JUST LIKE TRADITIONAL DEVICES

In place of a traditional device, install the connected device of the corresponding type: one for each control line. Remember that the device must always be powered; therefore, ensure that the phase and neutral cables are present. Once installed, the connected control is already working; you will therefore be able to switch the connected light on without the need to do anything further.



EXAMPLE OF A REDIRECT LIGHT POINT

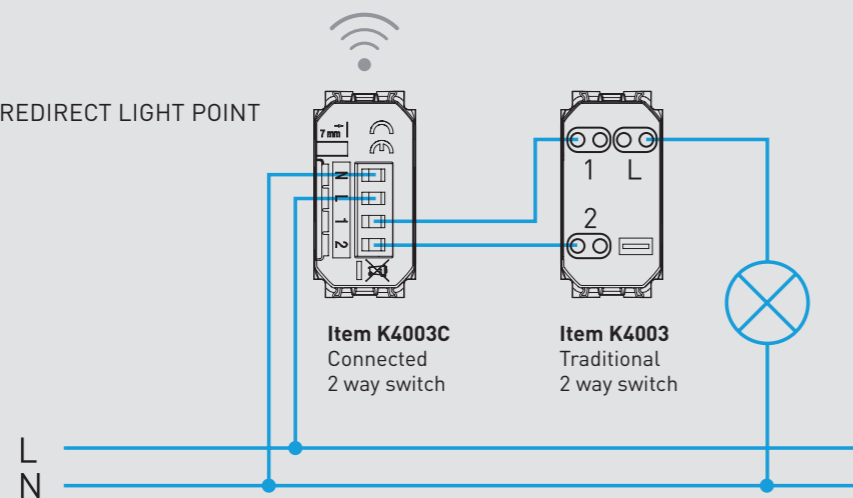

## 2. DEVICES CAN BE ASSOCIATED TO EACH OTHER BY SIMPLY PRESSING A PUSHBUTTON

A. Power the electric system

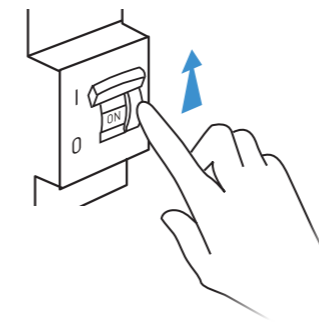

B. Press the In&Out master scenario control supplied with the gateway for 5 seconds

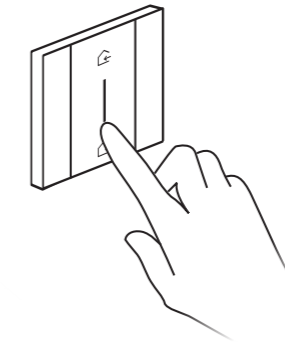

C. Devices are associated automatically. You can already use the IN&Out scenario control for the activation of the general "Going Out" control

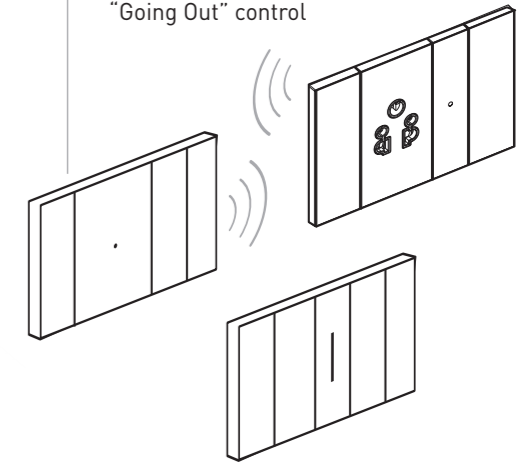

## 3. DOWNLOAD THE HOME+CONTROL APP FROM THE STORES AND FOLLOW THE GUIDED PROCEDURE TO DEFINE THE OBJECTS TO MANAGE



App Home + Control



## + THE SYSTEM MAY BE EXPANDED WITH WIRELESS CONTROLS ASSOCIATED TO THE DEVICES BEING CONTROLLED

A. Press the In&Out master scenario control supplied with the gateway for 5 seconds

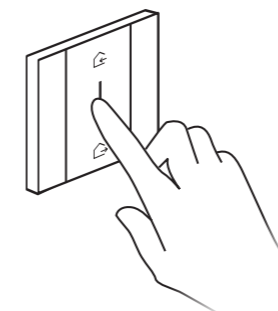

B. Place the devices to be associated in contact

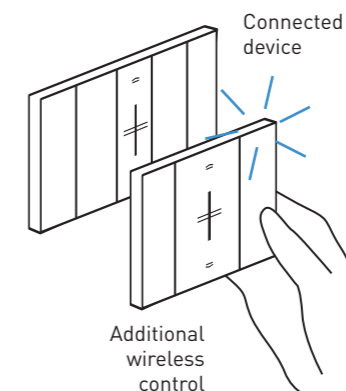

C. Install the wireless control anywhere you want, based on the needs of your customer

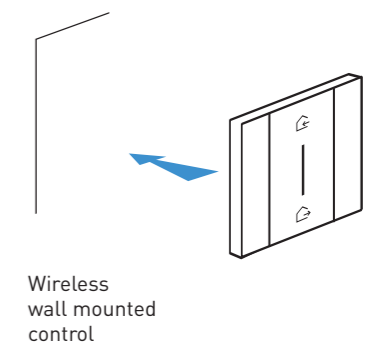





# The **new** connected thermostat Smarter

## What can you do with the connected thermostat?



### SETTING THE PROGRAMS

Using the Home + Control App, it is possible to set preset programs based on your habits



### AWAY

If you need to be away from home for a few days you can, via the APP, act remotely to adjust the thermostat (e.g. in antifrost mode) independent of the automatic programming.



### BOOST

The Boost function can be used to activate the heating or cooling system for a limited time (30, 60 or 90 minutes), irrespective of the set program and the ambient temperature.



### MONITORING OF CONSUMPTIONS

Using the Home + Control App, it is possible to easily manage and monitor consumptions.

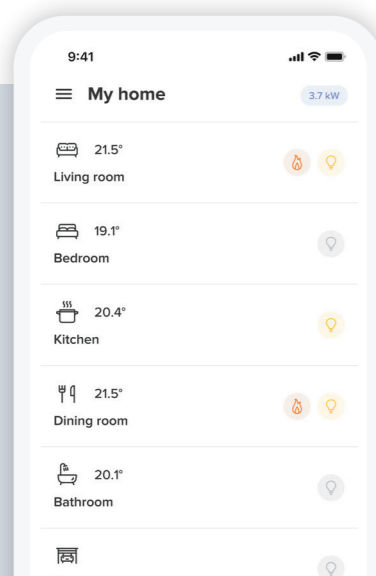

### WITH THE APP IT'S ALL EASIER

- Remotely manage the thermostat simply and intuitively
- Create and modify the weekly programs
- Manage the thermostat from several smartphones and different users
- Control several thermostats in the same home or different homes
- Manage the thermostat updates
- Combine the voice command with your favorite voice assistant (Amazon Alexa, Apple Home Kit or Google Home)

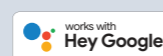
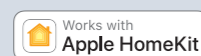

## The connected thermostat is simple and intuitive



Display the temperature and set it as desired



Display the set room temperature and humidity



Activate the Boost function

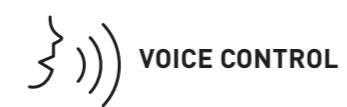



# INSTALL A MyHOME\_Up SYSTEM USING THE LIVING NOW RANGE

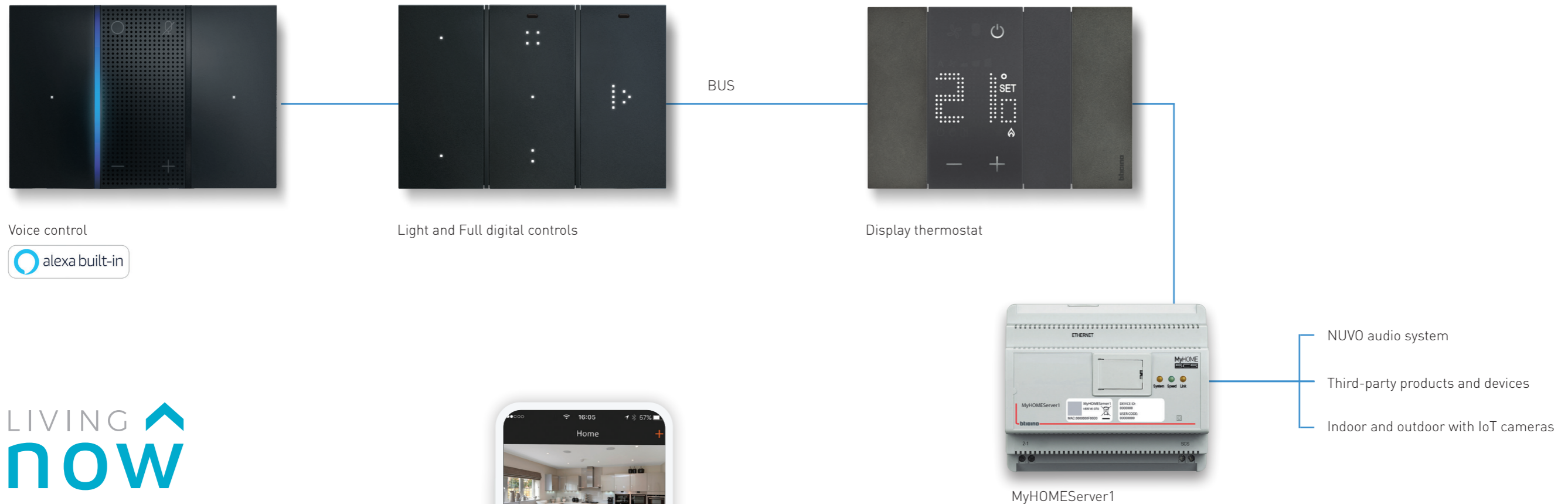

Voice control



Light and Full digital controls

BUS

Display thermostat

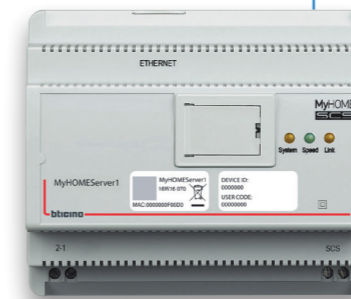

MyHOMEServer1

NUVO audio system

Third-party products and devices

Indoor and outdoor with IoT cameras



The range of home automation devices is completed by two innovative Living Now digital controls offering innovative control of your system:

- Voice control with built-in Amazon Alexa voice assistant
- Light and Full digital controls.

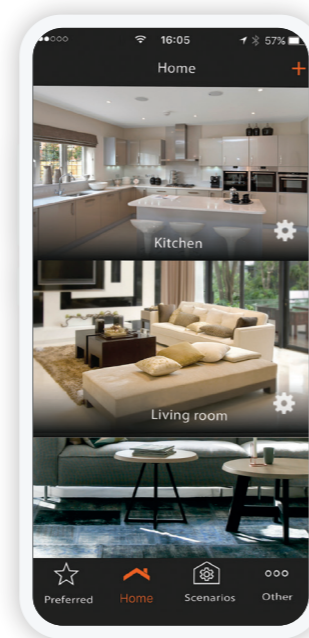

App MyHOME\_Up

### EVERYTHING UNDER CONTROL

Thanks to MyHOME\_Up, end users can manage their homes in full freedom: using Living Now manual controls, Touch Screen devices and Smartphones with the MyHOME\_Up App.

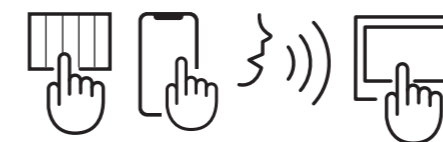

MyHOME\_Up system can be managed by voice through the Voice Control Alexa built-in and also with the Amazon and Google vocal assistants





# THE VOICE OF HOME AUTOMATION

## VOICE CONTROL: INNOVATIVE DEVICE WITH INTEGRATED AMAZON ALEXA VOICE ASSISTANT

Set each room of your home as you like with a voice control that controls the MyHOME\_Up system like never before.



**YOU ASK, ALEXA ANSWERS.**  
Use your voice to activate the home automation functions of your home: lights, shutters, scenarios, favourite music, or ask for any other information.

Note: with the "Welcome me home" scenario, it is possible to activate lights and shutters and disable the burglar alarm.



Note: with the "Relax" scenario, it is possible to activate lights and shutters, set a comfort temperature and listen to the preferred music through the NUVO multi-room system.



# A NEW WAY TO TOUCH HOME AUTOMATION

## LIGHT CONTROLS AND FULL CONTROLS: A MULTISENSORIAL EXPERIENCE

- New touch controls without cover plate
- Customised icons and leds using the app MyHOME\_Up
- Light and Full controls expandable to new functions

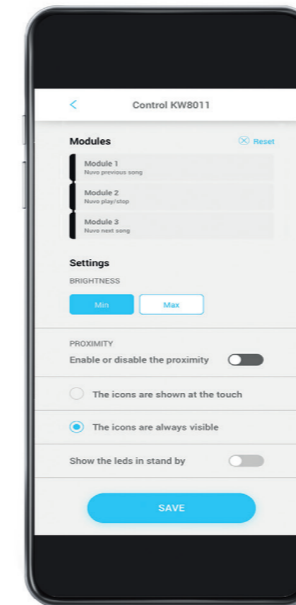
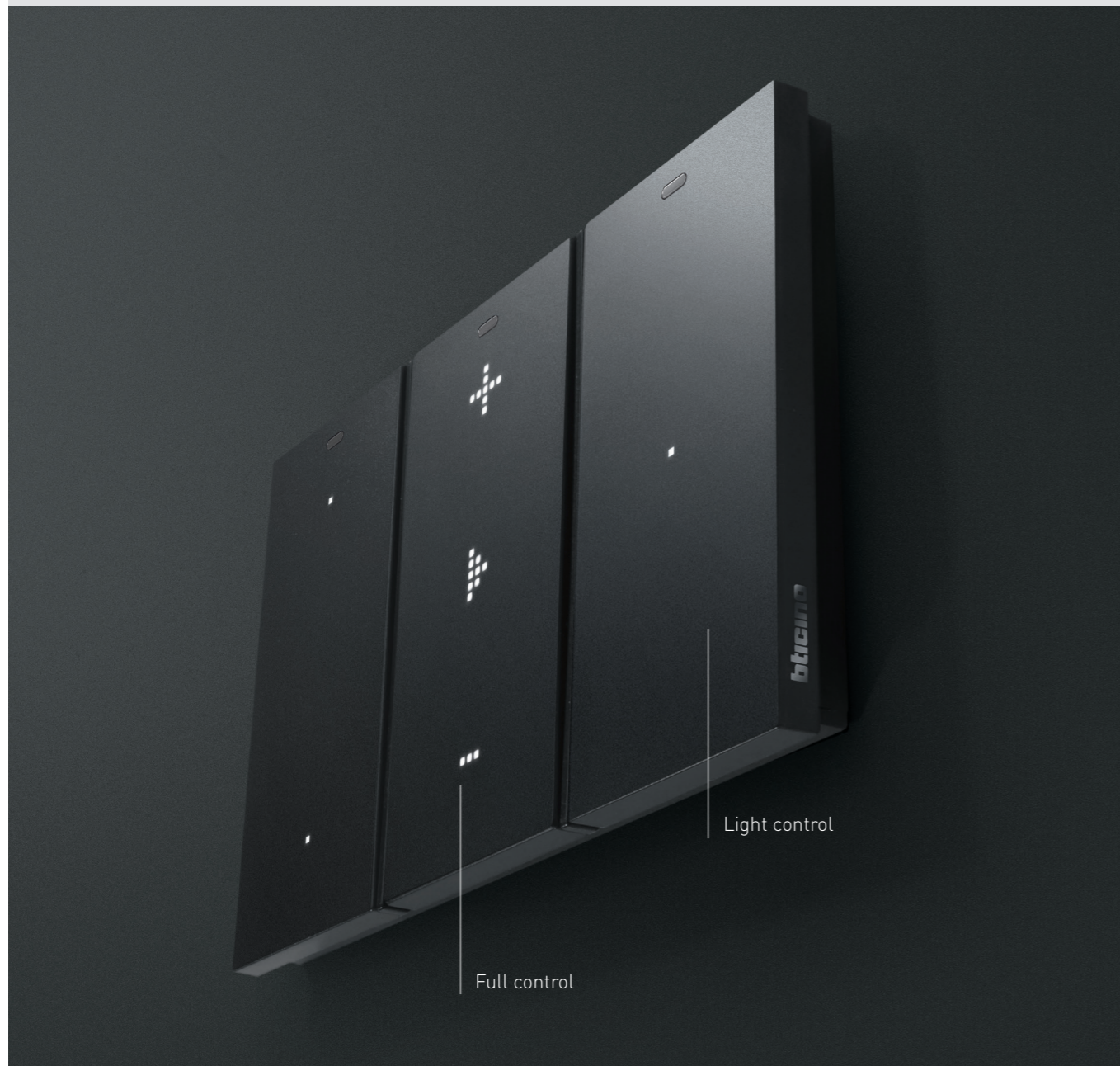

App Digital Controls

## CREATE CUSTOMISABLE FUNCTIONS

The function associated to the control device and the corresponding icon can be changed at any moment, also by the end user, using the app Digital Controls.

### FUNCTION MODIFICATION



From dimmer control



To shutter control

### FUNCTION EXTENSION



From the control of one light



To the control of two lights



LIGHT CONTROL  
To manage the lighting  
(1 or 2 lights, group and general)

## CHOOSE BETWEEN FULL AND LIGHT CONTROLS

Digital controls for every need.  
Two versions, endless customisation to be adapted to life style.

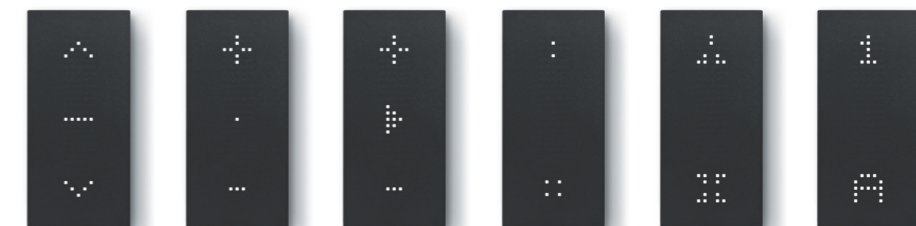

FULL CONTROL  
From 1 to 3 light, dimmer, rolling shutter, nuvo audio, load control and scenario.



**EXTEND THE CONTROL**

Expand the system by adding new control devices with a new frame. Without wiring.

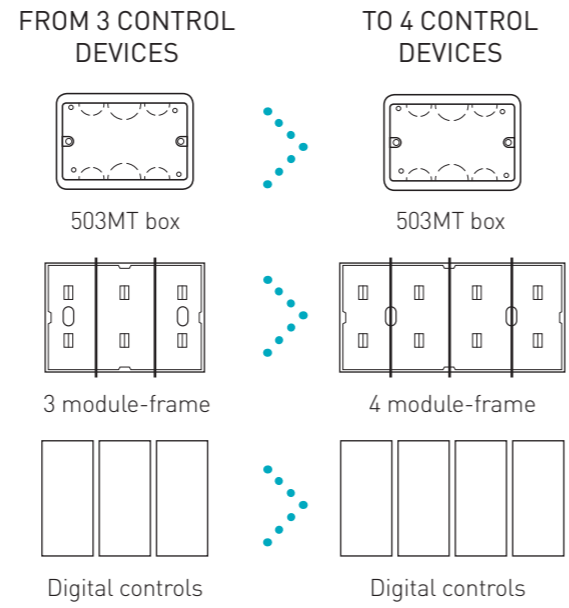

**MOVE THE POSITION**

With a simple operation, it is possible to change the position of a control device, maintaining its function. Without wiring.



FROM THE LIVING ROOM

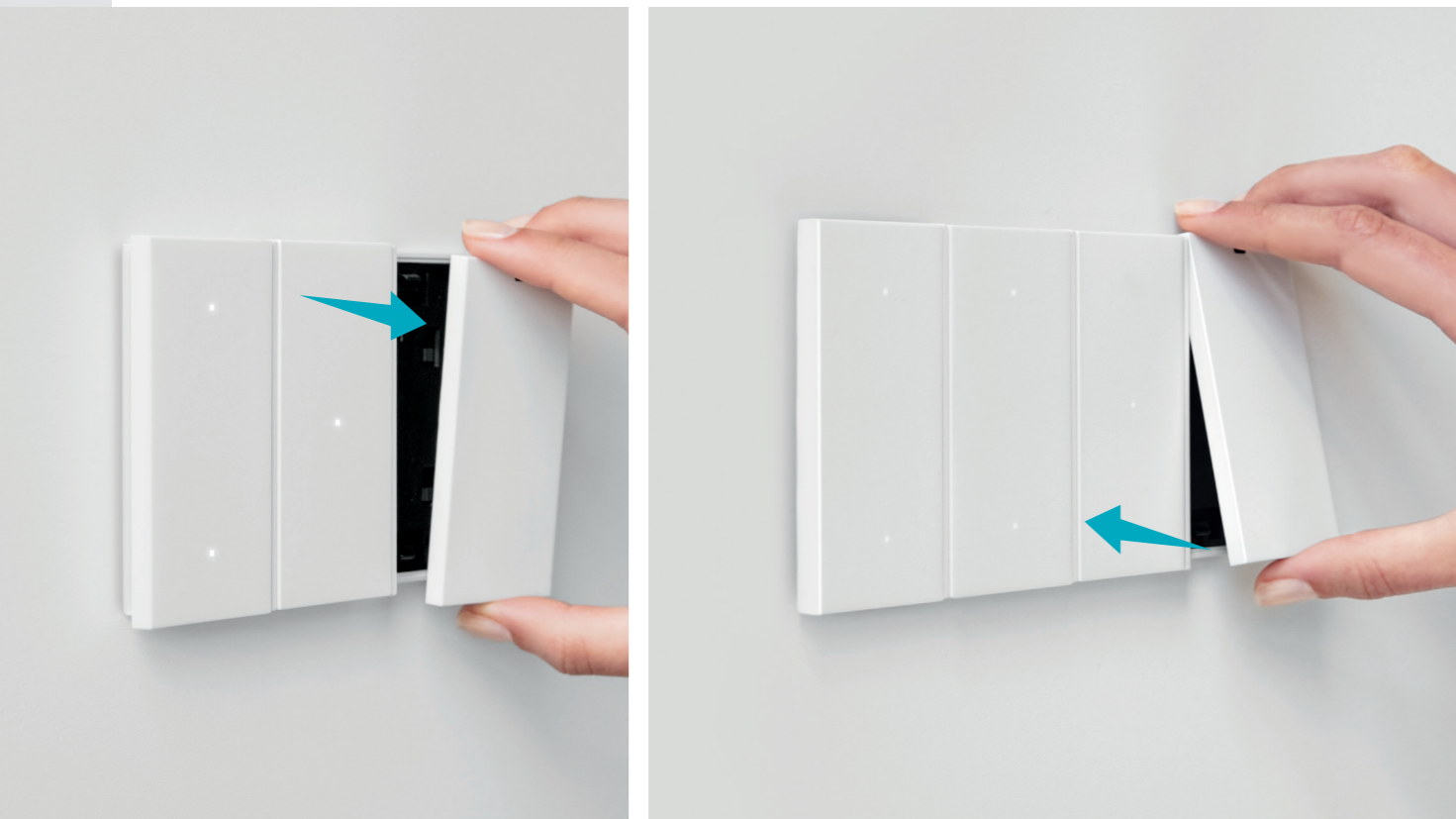

TO THE BEDROOM



# INSTALLATION OF DIGITAL CONTROLS

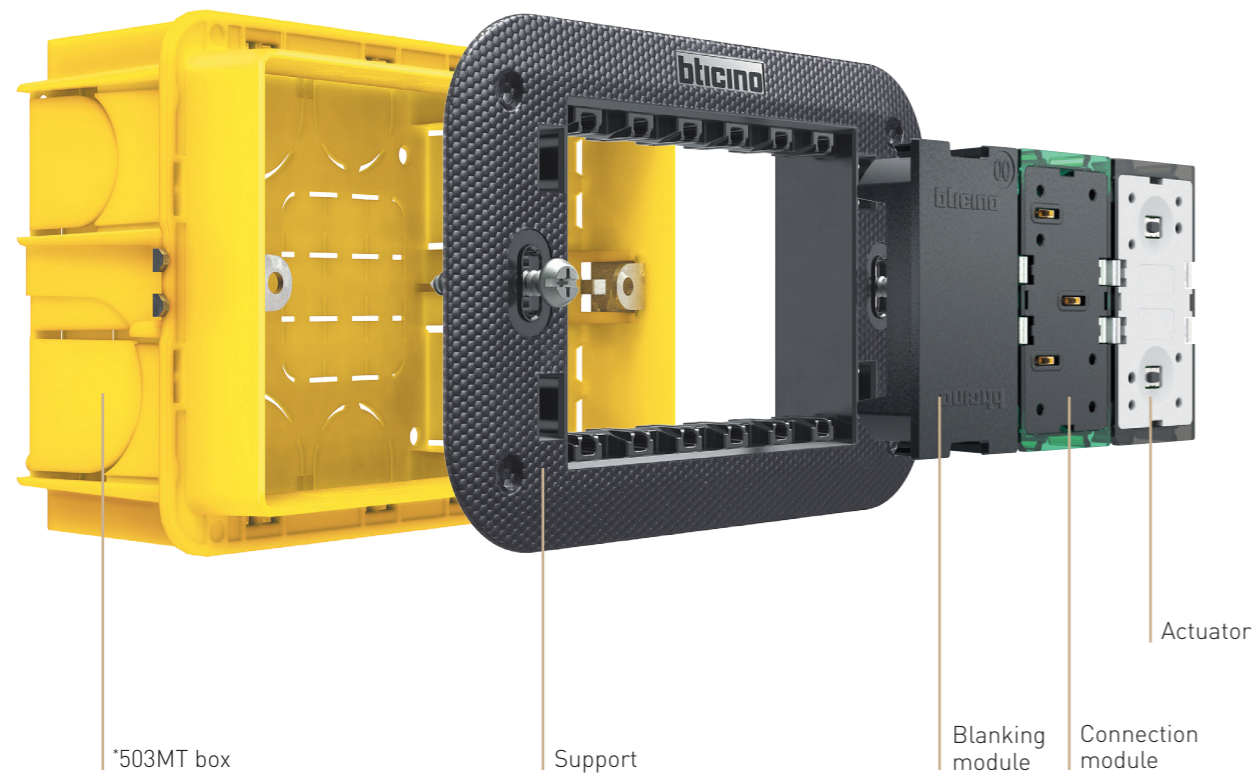

## FUNCTIONAL ELEMENTS

### INSTALLATION

With reference to the illustration, digital devices are installed in their respective flush mounted box and support, item K470..., using an appropriate "frame" with 27 Vd.c. control device power supply contacts. The Module for connection to the system BUS and any flush mounted actuators are installed on the support.

\*Boxes available in India are of metal only. For more detail refer page no. 86.

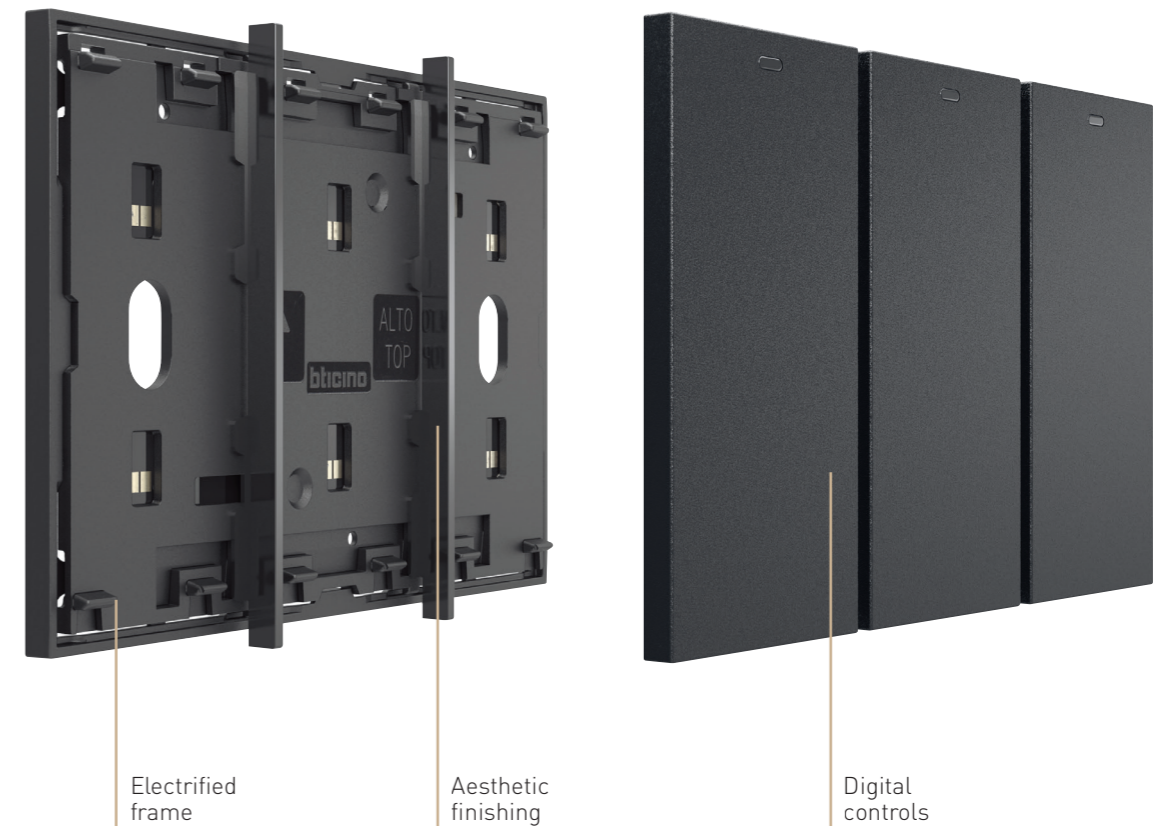

## AESTHETIC ELEMENTS

### INSTALLATION OF VOICE CONTROL

This operation is completed in a similar way as the installation of digital controls, but it requires the removal of the two vertical finishing elements from the electrified frame.

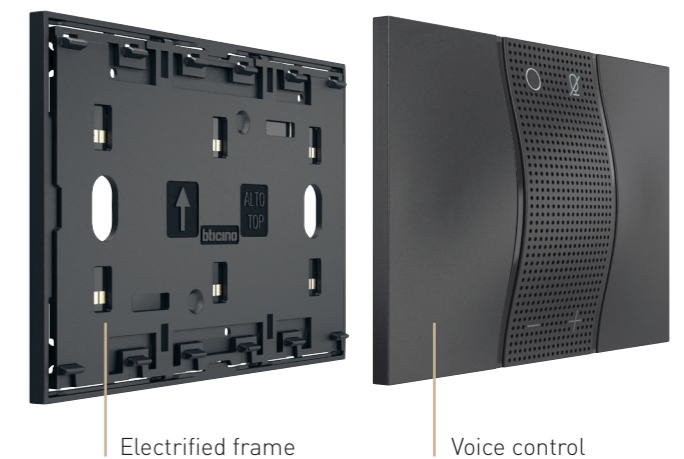



# ALWAYS PERFECT INSTALLATION

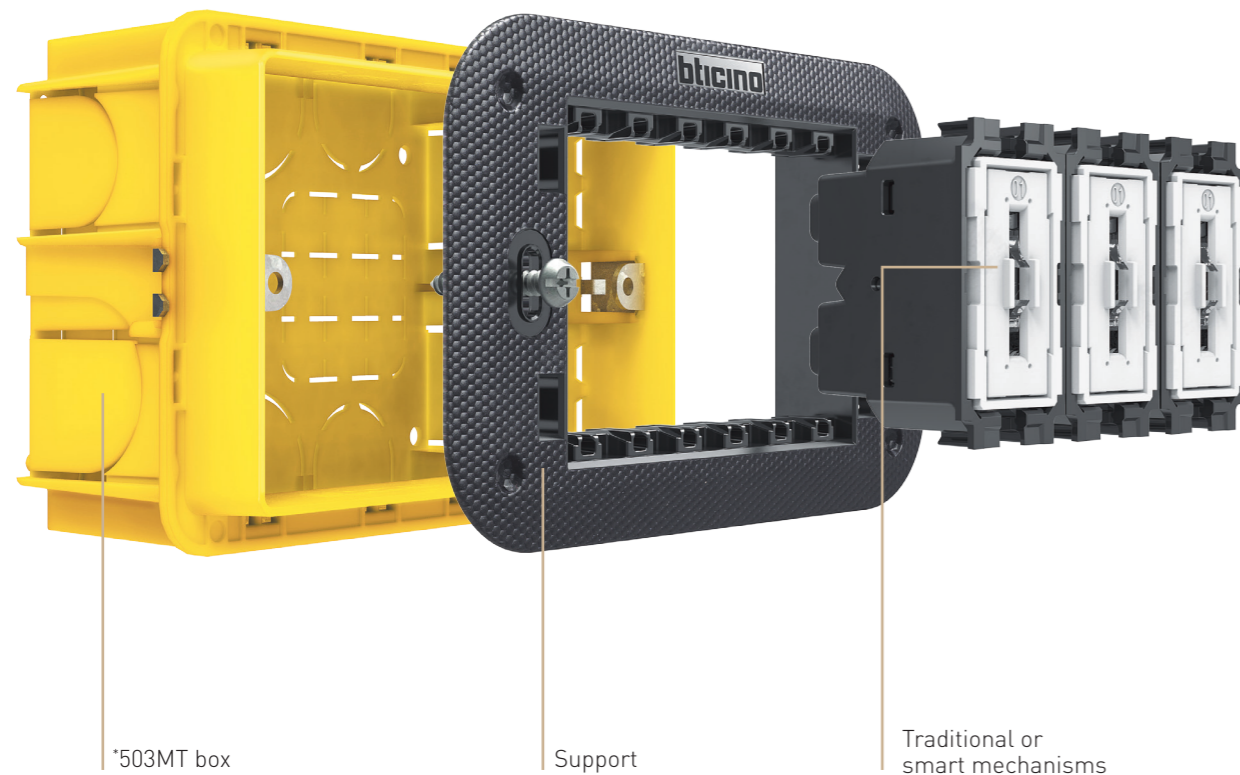

\*503MT box

Support

Traditional or smart mechanisms

## FUNCTIONAL ELEMENTS

### STANDARD INSTALLATION

Both in case of **traditional** and **connected devices**, installation is always standard, with the following characteristics:

- traditional wiring;
- flush mounted or plasterboard boxes, typically 2 to 6 modules;
- no configuration required.

### YOUR WORK DOES NOT CHANGE, BUT IS MADE EASIER

The rules and procedures for the installation of the electric system don't change. Moreover, with the installation of the aesthetic components at the end of the works, you will hand to your customer a perfect and perfectly looking system.

\*Boxes available in India are of metal only. For more detail refer page no. 82.

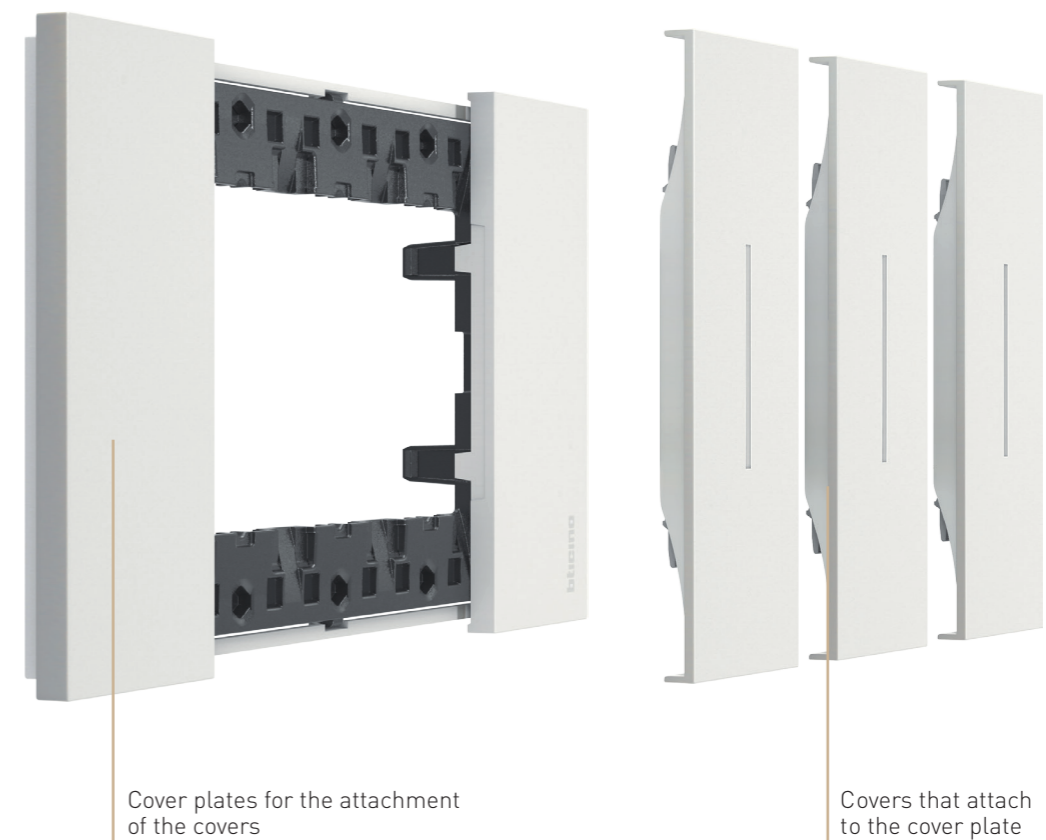

Cover plates for the attachment of the covers

Covers that attach to the cover plate

## AESTHETIC ELEMENTS

### SITE ACTIVITY SEQUENCE

- Install the system, fully working, but without aesthetic elements (cover plates and covers)
- Protect the light point using the protective shell (supplied with the support)
- After completing all the works (including the painting of the walls), install the cover plates and the covers

### MORE ADVANTAGES

- When repainting the walls in the future, the customer will be able to easily remove the light point aesthetic components, cover plates and covers, and just as easily replace them on completion of the works
- After a few years the customer decides to change light points?  
It is possible to simply change the covers, without touching the mechanisms



# SOLUTIONS FOR AN ALWAYS PERFECT INSTALLATION

## FULL TOUCH CONTROL: ERGONOMICS

All the surface is functional. It can be precisely activated from the top, bottom or centre, ensuring exceptional ergonomics.

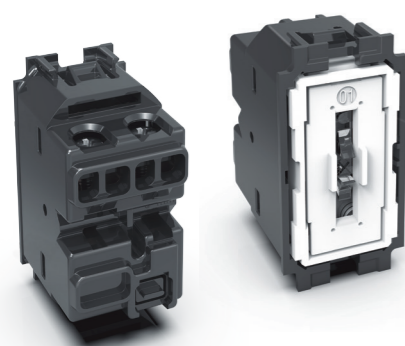

## FULL TOUCH CONTROL: ELECTRO MECHANICS

1) Tested with over 80,000 activations with the load connected; double than the standard requirements. This equals over 40 years of "normal" use.  
2) 10AX 250 V or 15AX 127 V, tested up to 700 A peak; also perfect for the new LED light bulbs, which generate significant peak current when switched on.

## SELF CENTERING SYSTEM

This patented cover self-centering system ensures that the control covers are always aligned with the other components of the light point, even after extended use.



## FLOATING FRAME

It's the flexible floating frame at the back of the cover plate that makes sure that the light point perfectly adheres to any wall.

The floating frame gives the possibility of:

- 1) hiding wall defects;
- 2) hiding any irregularity in flush mounted boxes their positioning;
- 3) hiding the external collars of plasterboard boxes.



## STRONGER SUPPORT

Up to 4 times stronger than the current version, thanks to the new geometry and high performance materials.



## BETTER PROTECTION

The support has a protective shell, which can be used to protect supports and mechanisms from possible damage during decorating activities, for example when painting the walls.



# AN INTERNATIONAL STANDARD

## MAIN MODULARITIES

With Living Now you can choose from a wide range of standards and modularity to get the solution that best suits your project.



ITALIAN / AUSTRALIAN  
CHINESE / INDIAN  
Standard



GERMAN AND FRENCH  
Standard



GERMAN AND FRENCH  
Standard

71 mm centre distance

## SOCKET OUTLETS STANDARD

The socket outlets range is complete of the main international standards.



INDIAN



ITALIAN



MULTISTANDARD



AMERICAN

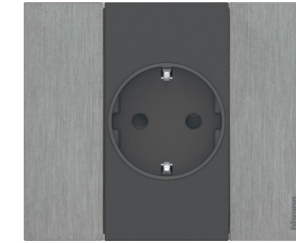

GERMAN



EURO / AMERICAN

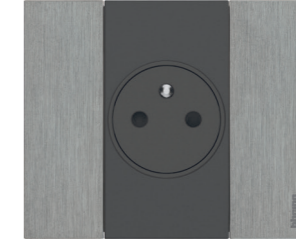

FRENCH / BELGIAN



CHINESE

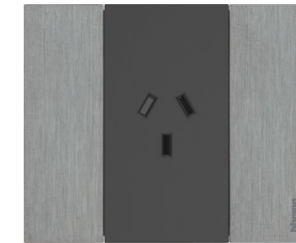

AUSTRALIAN



BRASILIAN



ISRAELI



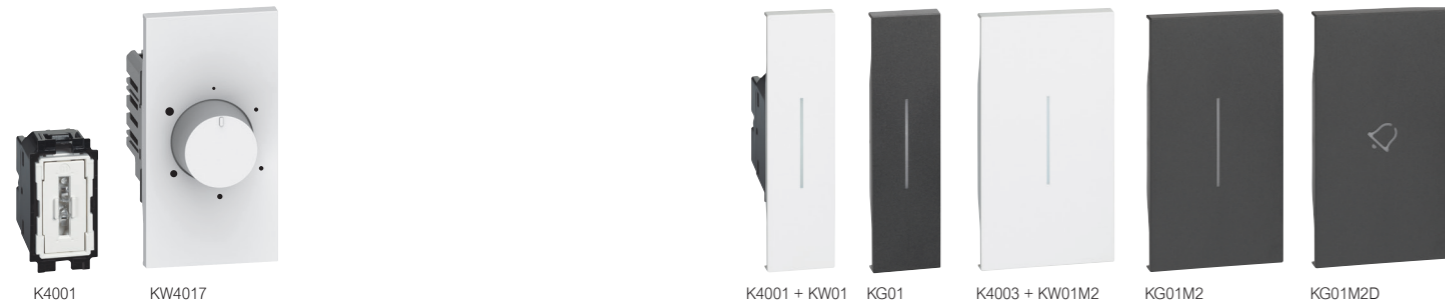

Devices to be completed with appropriate cover as indicated below

Item	Switch, two-way switch, pushbutton, intermediate switch 10 AX - 250 V~
○ K4001	1P 10 AX, 250 V~, 1-way switch, screw and plates terminals, lightable - 1 module
○ K4003	1P 10 AX, 250 V~ 2-way switch, screw and plates terminals, lightable - 1 module
○ K4005	<b>Pushbutton 10 A - 250 V~</b> 1P (NO) 10 A, 250 V~, pushbutton, screw and plates terminal, lightable - 1 module
□ KW4017 ■ KG4017 □ KM4017	<b>Fan regulator</b> Fan regulator 240V~ 100W 50Hz - The cover of the selected colour is supplied in the same box as the fan regulator - for Indian std. installations - 2 module

Item	Cover
□ KW01 ■ KG01 □ KM01	<b>1 module</b> Lightable cover for item K4001, K4003 and K4005
□ KW01M2 ■ KG01M2 □ KM01M2	<b>2 modules</b> Lightable cover for item K4001, K4003 and K4005
□ KW01X ■ KG01X □ KM01X	<b>Covers with symbols for controls</b>
□ KW01M2X ■ KG01M2X □ KM01M2X	<b>1 module - high brightness</b> Lightable cover for item K4001, K4003 and K4005
□ KW01A ■ KG01A □ KM01A	<b>2 modules - high brightness</b> Lightable cover for item K4001, K4003 and K4005
□ KW01M2A ■ KG01M2A □ KM01M2A	<b>1 module - light symbol</b> Lightable cover for item K4001, K4003 and K4005
□ KW01D ■ KG01D □ KM01D	<b>2 modules - light symbol</b> Lightable cover for item K4001, K4003, K4004 and K4005
□ KW01M2D ■ KG01M2D □ KM01M2D	<b>1 module - bell symbol</b> Lightable cover for item K4001, K4003 and K4005
□ KW01F ■ KG01F □ KM01F	<b>2 modules - bell symbol</b> Lightable cover for item K4001 and K4003
□ KW01M2F ■ KG01M2F □ KM01M2F	<b>1 module - key symbol</b> Lightable cover for item K4001, K4003 and K4005
	<b>2 modules - key symbol</b> Lightable cover for item K4001, K4003 and K4005

**- Notes:**  
- for the LEDs to use see the "Backlighting LEDs" section later on in the catalogue.  
- for solutions requiring 2-module covers for the main controls, it will be necessary to install two "half-module blanking modules" (item K4949) at the sides of the control, see examples of installation in the "Installation and cover plate range" section at the bottom of the catalogue.

□ White colour cover    ■ Black colour cover    □ Sand colour cover    ○ Neutral item (without cover)

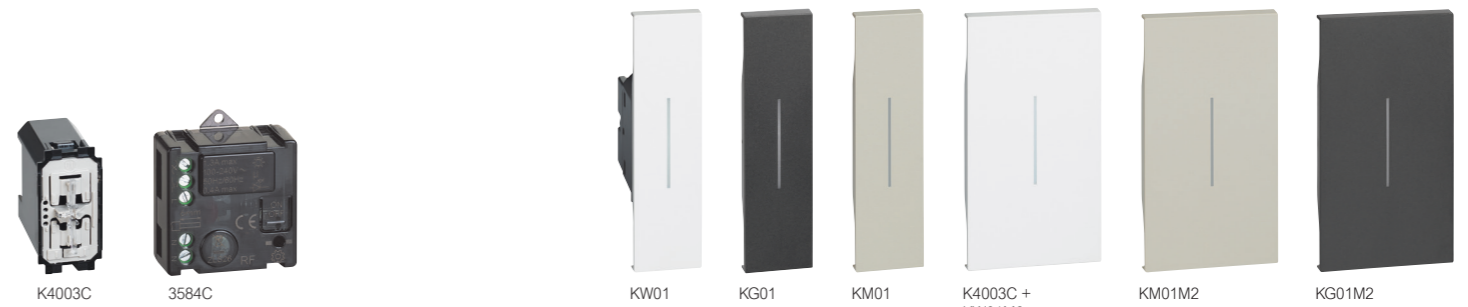

Devices to be completed with appropriate cover as indicated below

Item	Connected switches and light relay	Cover
○ K4003C	Connected 2-ways switch. It allows to control lights locally or remotely. The connected 2ways switch has the same installation and usability of a traditional 2ways switch and it is compatible with all loads with max power 250 W. It s equipped with a blue LED light used always on for localization modality or on, when the light is on for the load status modality. It can be associated with "wireless light switches". Caution: Must be connected to the neutral. Power supply 110-230 V~ - 1 module	□ KW01 ■ KG01 □ KM01 <b>1 module</b> Lightable covers for item K4003C
○ 3584C	Connected lighting micromodule. It allows to control lights locally or remotely. It is compatible with all loads with max power 300 W. It can be connected to one or more traditional push-button or associated with "wireless light switches". It is installed as a traditional rele in the box (behind the button) or in derivation boxes. Caution: Must be connected to the neutral. Power supply 110-230 V~ - 1 module	□ KW01M2 ■ KG01M2 □ KM01M2 <b>2 modules</b> Lightable covers for item K4003C

Three-point lighting control with pushbuttons and connected lighting micromodule, item 3584C, installed instead of a traditional relay

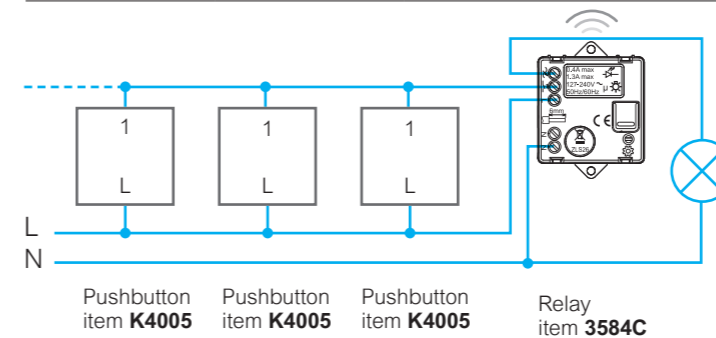

Pushbutton item **K4005**    Pushbutton item **K4005**    Pushbutton item **K4005**    Relay item **3584C**

□ White colour cover    ■ Black colour cover    □ Sand colour cover    ○ Neutral item (without cover)

Note: for the use of the connected devices, the gateway, item **K4500C** must be installed as part of the system.

If the gateway is connected to the internet through the Wi-Fi network, it will be possible to manage the system from the home using the specific **HOME + CONTROL** App



HOME + CONTROL

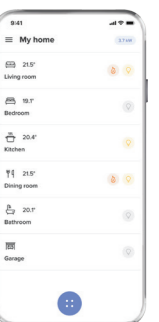



Traditional electrical system  
dimmer



Devices to be completed with appropriate cover as indicated below

Item	Dimmer
○ K4411	<b>Universal dimmer</b> Universal pushbutton dimmer - resistive/ inductive/ capacitive/fluorescent/compact/ dimmer LED. 100 to 240 V~ 50 ÷ 60 Hz - connection without neutral - 2 modules

Item	Cover
<input type="checkbox"/> KW19 <input checked="" type="checkbox"/> KG19 <input type="checkbox"/> KM19	<b>1 module</b> Cover for item K4411

DIMMER K4411 - LOADS MANAGED TABLE

		R		L		C/L		Dimmable	Dimmable
		Light bulb	Light bulb	Light bulb + LED	Light bulb + LED	Light bulb + LED	Light bulb + LED	LED	LED
+35°C 0°C 100- 240 V~ 50/60 Hz 2 x 2.5 mm²	240 V	Max. 400 W	400 W	400 VA	200 VA	400 VA	200 VA	75 W or max. 10 lamps	75 W or max. 10 lamps
		Min. 3 W	3 W	3 VA	3 VA	3 VA	3 VA	3 W	3 W
100 V	Max.	200 W	200 W	200 VA	100 VA	200 VA	100 VA	37 W or max. 10 lamps	37 W or max. 10 lamps
	Min.	3 W	3 W	3 VA	3 VA	3 VA	3 VA	3 W	3 W

Living Now IoT smart electrical system  
dimmer  
eliot



Devices to be completed with appropriate cover as indicated below

Item	Connected Dimmer/Switch
○ K4411CM2	<b>Universal dimmer</b> Dimmer/switch without neutral. It allows to control lights locally or remotely, with the dimmer functionality that can be activated from APP Home+Control. It has the same installation and usability of a traditional switch and it is compatible with all loads (LED, halogen) with power 5-300 W at 230 V. It's equipped with a blue LED light used for localization modality or load status modality, configurable by APP. It can be connected associated with "wireless light switches". It doesn't require connection to the neutral, it comes with an active compensator. Power supply 110-230 V~ - 2 modules

Item	Cover
<input type="checkbox"/> KW33M2 <input checked="" type="checkbox"/> KG33M2 <input type="checkbox"/> KM33M2	<b>2 modules</b> Cover for item K4411CM2

Note: for the use of the connected devices, the gateway, item **K4500C** must be installed as part of the system.

If the gateway is connected to the internet through the Wi-Fi network, it will be possible to manage the system from the home using the specific **HOME + CONTROL** App

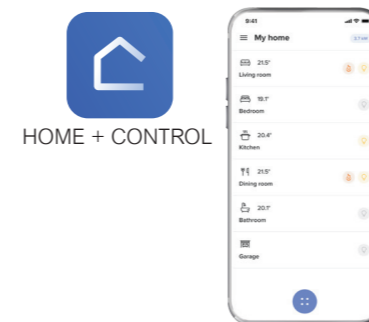

Dimmer/switch item K4027C with remote pushbuttons

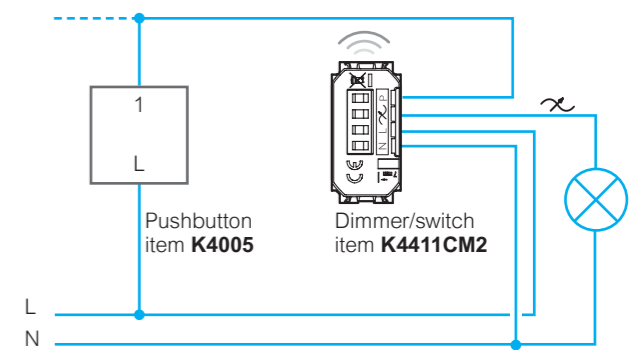





Devices to be completed with appropriate cover as indicated below

- | Item  | Indian standard switches  |
|---|---|
| <input type="checkbox"/> KW4301V16<br><input checked="" type="checkbox"/> KG4301V16<br><input type="checkbox"/> KM4301V16 | 1P 16 AX, 230 V~, 1-way switch, screw and plates terminals, with white LED for backlighting (the LED is not interchangeable) - 1 module |
| <input type="checkbox"/> KW4301V20<br><input checked="" type="checkbox"/> KG4301V20<br><input type="checkbox"/> KM4301V20 | 1P 20 AX, 230 V~, 1-way switch, screw and plates terminals, with white LED for backlighting (the LED is not interchangeable) - 1 module |
| <input type="checkbox"/> KW4302V32<br><input checked="" type="checkbox"/> KG4302V32<br><input type="checkbox"/> KM4302V32 | 2P 32 A, 230 V~ switch, with white LED for backlighting (the LED is not interchangeable) - 2 module                                     |

- | Item   | Cover  |
|--|--|
| <input type="checkbox"/> KW02<br><input checked="" type="checkbox"/> KG02<br><input type="checkbox"/> KM02       | <b>1 module</b><br>Cover for Item KW4301V16, KW4301V20<br>Cover for Item KG4301V16, KG4301V20<br>Cover for Item KM4301V16, KM4301V20 |
| <input type="checkbox"/> KW02M2<br><input checked="" type="checkbox"/> KG02M2<br><input type="checkbox"/> KM02M2 | <b>2 module</b><br>Cover for Item KW4302V32, KM4302V32 and KG4302V32   |



Devices to be completed with appropriate cover as indicated below

- | Item                           | IR switches   |
|--------------------------------|---|
| <input type="checkbox"/> K4431 | Switch with passive infrared ray movement sensor, suitable for all types of load including LED lamps - 3 wires - variable-threshold twilight circuit with possibility of exclusion - timing circuit to delay switching off adjustable from 30 seconds to 10 minutes - 230 V~ power supply - 1 module<br><b>Note:</b> for further information, see the technical section at the end of the Catalogue   |
| <input type="checkbox"/> K4432 | Switch with passive infrared ray movement sensor, suitable for all types of load including LED lamps - 3 wires - variable-threshold twilight circuit with possibility of exclusion - timing circuit to delay switching off adjustable from 10 seconds to 10 minutes - 230 V~ power supply - 2 modules<br><b>Note:</b> for further information, see the technical section at the end of the Catalogue  |
| <input type="checkbox"/> K4430 | switch with passive infrared ray movement sensor, suitable for all types of load including LED lamps - 2 wires - variable-threshold twilight circuit with possibility of exclusion - timing circuit to delay switching off adjustable from 10 seconds to 10 minutes - it has a selector switch for operating type ON - AUTO - OFF. It is possible to choose between two types of configuration:<br>1) visible selector switch (install the selector switch supplied and use the cover item ...17SL)<br>2) hidden selector switch (do not install the selector switch supplied and use the cover item ...17) - power supply 230 V~ - 2 modules<br><b>Note:</b> for further information, see the technical section at the end of the Catalogue. |

- | Item   | Cover   |
|--|---|
| <input type="checkbox"/> KW16<br><input checked="" type="checkbox"/> KG16<br><input type="checkbox"/> KM16       | <b>1 module</b><br>Cover for item K4431         |
| <input type="checkbox"/> KW17<br><input checked="" type="checkbox"/> KG17<br><input type="checkbox"/> KM17       | <b>2 modules</b><br>Cover for item K4432, K4430 |
| <input type="checkbox"/> KW17SL<br><input checked="" type="checkbox"/> KG17SL<br><input type="checkbox"/> KM17SL | Cover for item K4430                            |

- **Note:** use item K4430 with ..17 or ..17SL covers  
- cover .. 17SL: cover providing direct access to the selector. The device operating mode can be changed at any time as the selector is always exposed.  
- cover .. 17: cover not providing access to the selector. To change the operating mode using the selector on the product, it will be necessary to remove the cover



## Traditional electrical system thermostats



KW4441

KG4441

KM4441

Item

### Electronic thermostats

- KW4441
- KG4441
- KM4441

Electronic room thermostat - relay output with 1 contact in switching free of 5(2)A potential.  
- power supply 230 V~ - 2 modules



## Living Now IoT smart electrical system thermostats eliot



XW8002

XG8002

XM8002

XW8002W

The Smarter connected thermostat, together with the dedicated HOME+CONTROL APP, is a device which allows you to adjust and monitor the temperature in the rooms precisely and accurately; all the programming and most of the functions are performed simply and intuitively using the APP. Thanks to its Wi-Fi connection, Smarter can be programmed and controlled remotely; it can also display the temperature and humidity measured in the room. The temperature level can be set locally for manual operation and the Boost mode can be activated. The Boost forces the switching on of the system for a limited time (30, 60 or 90 minutes) independent of the measured and programmed temperature. It's also possible to set a different temperature in each room of the house for the maximum comfort, thanks to its compatibility smart radiator valves. Smarter can also be controlled with Google, Amazon Alexa and Apple Home Kit voice assistants.

#### Features:

- 110 ÷ 230 V~, 50/60 Hz power supply;
- 2 W max absorption;
- maximum cable section 1 x 1.5mm<sup>2</sup>;
- temperature measurement 5 ÷ 40°C;
- temperature set-point 5 ÷ 40°C;
- increase of 0.5°C;
- 1-contact output in switching free of potential 5(2)A.

#### Types of installation:

- flush mounted, on boxes item 503E or 500 (for item 500 use the wall dowels)
- plasterboard, on boxes 2 module and 3 module

It is available in three colours: white (XW8002), sand (XM8002) and black (XG8002).

Item

### Connected thermostats

- XW8002
- XG8002
- XM8002

White  
Black  
Sand



XW8002W



Features: as XW8002.  
Installation on the wall, using screws and dowels suitable for the installation surface (brickwork, plasterboard, tiles etc.).  
It is only available in white.



App HOME + CONTROL for  
management of connected devices

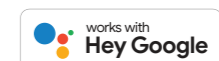











Devices to be completed with appropriate cover as indicated below

Item	Connected devices for energy management	Item	Cover
○ K4531C	 <p>Connected socket module - wiring to a power outlet, allows to remotely control appliances and check the consumption ( instantaneous, daily, monthly ). It is also possible to receive notifications in case of anomalous consumption. The connected socket module is compatible with any device electric and large appliances up to 16 A 3680 W max. (protected against overloads). It is equipped with a LED light lit in blue when it is on. This option can be enabled or disabled in the "Home+Control" app. It can be associated with "wireless light switches". Power supply 110-230 V~ - 1 module</p>	<input type="checkbox"/> KW31 <input checked="" type="checkbox"/> KG31 <input type="checkbox"/> KM31	<p><b>1 module</b></p>  <p>Cover for item K4531C</p>



Devices to be completed with appropriate cover as indicated below

Item	India standard sockets	Item	Cover for Indian standard sockets
○ K4139IN	 <p>Indian multistandard socket - 2 modules</p>	<input type="checkbox"/> KW59 <input checked="" type="checkbox"/> KG59 <input type="checkbox"/> KM59	<p><b>3 modules</b></p>  <p>Cover for Item K4139IN</p>
○ K4156	 <p>2P+E 6/10A 240V~ and 15A 127V~ Indian and Euro-US std. socket - shuttered contact tubes - 2 modules</p>	<input type="checkbox"/> KW56 <input checked="" type="checkbox"/> KG56 <input type="checkbox"/> KM56	 <p>Cover for Item K4156</p>
○ K4157	 <p>2P+E 6/16A 240V~ Indian std. Combined socket - shuttered contact tubes - 2 modules</p>	<input type="checkbox"/> KW57 <input checked="" type="checkbox"/> KG57 <input type="checkbox"/> KM57	 <p>Cover for Item K4157</p>





Devices to be completed with appropriate cover as indicated below

Item	USB charger
<input type="radio"/> K4285C1	5 Vdc type A USB charger only for charging electronic devices up to 1,500 mA - 110-230 V 50-60 Hz DIRECT power supply - 1 module
<input type="radio"/> K4285C2	5 Vdc type A USB charger for quick charge of one single electronic device up to 3,000 mA or simultaneous charging of two devices up to 1,500 mA - 110-230 V 50-60 Hz DIRECT power supply - 1 module
<input type="radio"/> K4286C1	5 Vdc type C USB charger only for charging electronic devices up to 1,500 mA - 110-230 V 50-60 Hz DIRECT power supply - 1 module
<input type="radio"/> K4286C2	5 Vdc type C USB charger for quick charge of one single electronic device up to 3,000 mA or simultaneous charging of two devices up to 1,500 mA - 110-230 V 50-60 Hz DIRECT power supply - 2 modules
<input type="radio"/> K4287C2	5 Vdc type A and C USB charger for quick charge of single electronic devices up to 3,000 mA or simultaneous charging of two devices up to 1,500 mA - 110-230 V 50-60 Hz DIRECT power supply - 2 modules

Item	Cover for USB charger
<input type="checkbox"/> KW10C <input checked="" type="checkbox"/> KG10C <input type="checkbox"/> KM10C	<b>1 module</b> Cover for item K4285C1 and K4286C1
<input type="checkbox"/> KW12C <input checked="" type="checkbox"/> KG12C <input type="checkbox"/> KM12C	<b>2 modules</b> Cover for item K4286C2, K4286C2 and K4287C2

Item	Induction charger
<input type="checkbox"/> KW4286CW2	It allows the quick and wireless charging of smartphones with induction receiver up to 1,000 mA (compliant with WPC Qi standard). The antislip support surface is inclined by 10°. Antitheft lock function. Energy performance >85%. Equipped with a 3,000 mA type-A USB port for the powering of a second device - 12 W. Possibility of simultaneous recharging of two devices, up to 500 mA wirelessly, and up to 1,200 mA through the USB port. Dimension 136.5 x 70 x 56.5 mm. The cover of the selected colour is supplied in the same box as the charger.

White colour cover     Black colour cover     Sand colour cover     Neutral item (without cover)



Devices to be completed with appropriate cover as indicated below

Item	TV socket 1 module
<input type="radio"/> K4202F	Type F TV coaxial connector - impedance 75 Ω - screw hook - 1 module

Item	Cover for TV socket 1 module
<input type="checkbox"/> KW08 <input checked="" type="checkbox"/> KG08 <input type="checkbox"/> KM08	<b>1 module</b> Cover for item K4202F
<input type="checkbox"/> KW08M2 <input checked="" type="checkbox"/> KG08M2 <input type="checkbox"/> KM08M2	<b>2 modules</b> Cover for item K4202F

Item	RJ45 connectors
<input type="checkbox"/> KW4279C5E <input checked="" type="checkbox"/> KG4279C5E <input type="checkbox"/> KM4279C5E	Connectors for data/telephony transmission These connectors can be used for 4-pair signal transmission systems - 1 module
<input type="checkbox"/> KW4279C6 <input checked="" type="checkbox"/> KG4279C6 <input type="checkbox"/> KM4279C6	

Category	Type of connection
5E UTP	TOOLLESS IDC
6 UTP	TOOLLESS IDC

Item	Cover for RJ45, RJ11 connector
<input type="checkbox"/> KW07 <input checked="" type="checkbox"/> KG07 <input type="checkbox"/> KM07	<b>1 module</b> Cover for all the RJ45 and RJ11 connectors

Item	RJ11 connectors
<input type="checkbox"/> KW4258RJ11 <input checked="" type="checkbox"/> KG4258RJ11 <input type="checkbox"/> KM4258RJ11	These connectors are designed to meet the needs linked with telephonic interconnections - 1 module

Category	Type of connection
RJ11	K10

White colour cover     Black colour cover     Sand colour cover     Neutral item (without cover)





Devices to be completed with appropriate cover as indicated below

Item	A/V connector
○ K4284P	Pre-connected HDMI 1.4 connector - 1 module
Item	Bells and buzzer
○ K4356V230	<b>Buzzer</b> 230 V~ buzzer - 12 VA - 80 dB - 1 module
Item	Reading lamp
<input type="checkbox"/> KW4362 <input checked="" type="checkbox"/> KG4362 <input type="checkbox"/> KM4362	It is installed at the bedhead giving directional lighting. It has a flexible arm so that the lighting arm can be directed. The brightness can be dimmed by pressing the integrated ON/OFF control for a long time. It can also be connected to a remote control and, if necessary, the integrated control can be disabled with a 30 sec. press. - LED lamp - 3W consumption - Luminous flux 110 lumen (equivalent to 15 W incandescence) - Life 40,000 hours - 1 module (flush-mounted). Cover supplied with device.

Item	Cover for A/V connectors
<input type="checkbox"/> KW14 <input checked="" type="checkbox"/> KG14 <input type="checkbox"/> KM14	<b>1 module</b> Cover for item K4284P
Réf.	Cover for bell and buzzer
<input type="checkbox"/> KW15 <input checked="" type="checkbox"/> KG15 <input type="checkbox"/> KM15	<b>1 module</b> Cover for item K4356V230



Devices to be completed with appropriate cover as indicated below

Item	Key card switches
○ K4549	Key card switch for the power supply inside the hotel room - slot light with built-in lamp - 30 second switch-off delay - power supply 230 V~. The completion of the light point requires two "half-module blanking modules" (item K4949) at the sides of the badge holder.
○ K4548	Key card switch for the power supply inside the hotel room - slot light with built-in lamp - 30 second switch-off delay - power supply 230 V~ - with RFID technology recognition. The completion of the light point requires two "half-module blanking modules" (item K4949) at the sides of the badge holder.
Item	Off-door controls
○ K4027H	1P 10 AX, 250 V~ changeover switch, double-key 1-0-2 for Hotel, LIT - 1 module (The LED is replaceable with item K4743V230RG)
○ K4373	Lampholder with two built-in LEDs, green and red. Can be used as out of room visual signal with double notification: do not disturb and make up the room - The LEDs cannot be replaced - 127/ 230 V~ power supply - 1 module
Item	Shaver sockets
<input type="checkbox"/> KW4177 <input checked="" type="checkbox"/> KG4177 <input type="checkbox"/> KM4177	Shaver socket with insulation transformer - input voltage 230 V~ 50/60 Hz - output voltage 115/230 V~ 20 VA. The cover of the selected colour is supplied in the same box as the shaver socket - 3 modules

Item	Cover for functions for hotel
<input type="checkbox"/> KW06H <input checked="" type="checkbox"/> KG06H <input type="checkbox"/> KM06H	<b>1 module</b> Cover for item K4027H
<input type="checkbox"/> KW11H <input checked="" type="checkbox"/> KG11H <input type="checkbox"/> KM11H	Cover for item K4373
<input type="checkbox"/> KW22M2 <input checked="" type="checkbox"/> KG22M2 <input type="checkbox"/> KM22M2	<b>2 modules</b> Cover for item K4549 et K4548
<input type="checkbox"/> KW22 <input checked="" type="checkbox"/> KG22 <input type="checkbox"/> KM22	<b>3 modules</b> Cover for item K4549 et K4548



**Traditional electrical system**  
LED and blanking modules



Devices to be completed with appropriate cover as indicated below

Item	LED for control and socket lighting
K4743V230T	LED for backlighting of the following "basic control devices": K4001, K4003 and K4005
LN4743/230T	white LED - 230 V~ - high luminosity for daytime load notification
	white LED - 230 V~ - night signal

Item	Blanking modules
K4950	Blanking module - 1 module
K4953	Blanking module with output Ø 9 mm - 1 module

Item	Installation accessory
K4949	1/2 module blanking module - it does not require the cover

Item	Cover for Blanking modules
<input type="checkbox"/> KW00	1 module Cover for item K4950
<input checked="" type="checkbox"/> KG00	
<input type="checkbox"/> KM00	
<input type="checkbox"/> KW08	Cover for item K4953
<input checked="" type="checkbox"/> KG08	
<input type="checkbox"/> KM08	

**EXAMPLES OF LED CONNECTION ON A SWITCH**

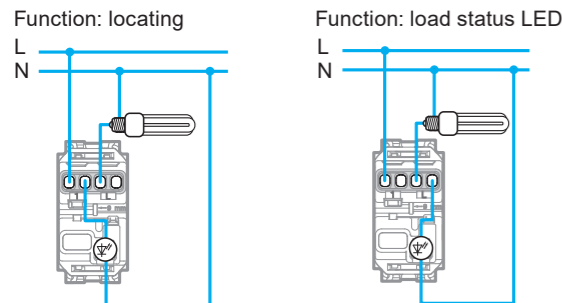

Control backlighting led connection

Note for the connection of 230 V.a.c. LEDs for the backlighting of control devices: when LEDs are fitted to help locate the control itself, it must be taken into account that energy saving and fluorescent lamps do not allow in series connection of the LED on the load. It is therefore necessary to also take a neutral conductor near the control, so that the LED may be connected directly between phase and neutral, and will always be on.

White colour cover     Black colour cover     Sand colour cover    ○ Neutral item (without cover)

**Living Now**  
support frames and IP44 housing

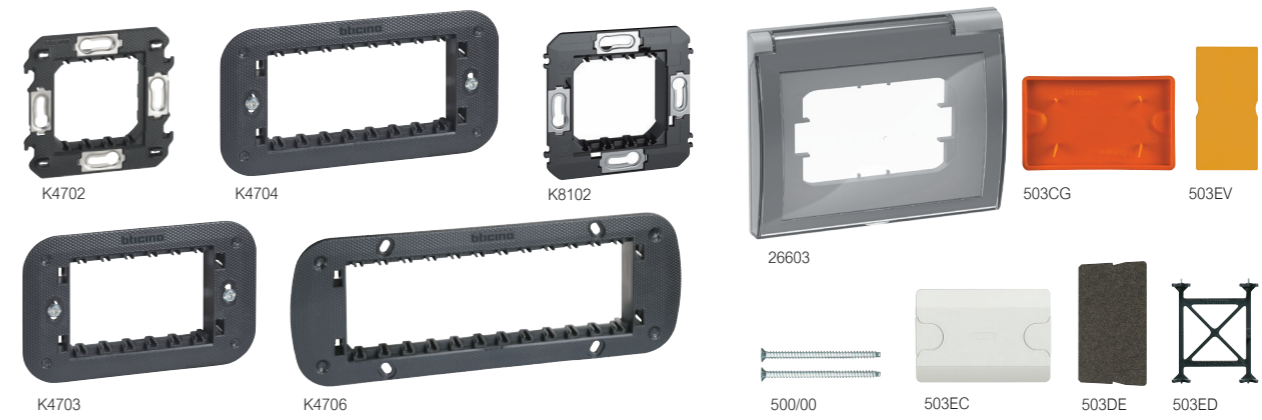

Item	Supports
K4702	2-module support frame supplied with protective shell
K4703	3-module support frame supplied with protective shell
K4704	4-module support frame supplied with protective shell
K4706	6-module support frame supplied with protective shell
500/00	Pair of 35 mm screws for the fastening of the supports to boxes installed below the plaster work.
K8102	Support for the installation of the electrified frame item KW8102P1, KG8102P1, KM8102P1 in 2 module box
KA4902	Accessorie for 2 module support frame - to be used on Indian standard installations

Item	IP44 housing
26603	IP44 protection cover (guaranteed when closed). Ideal for installation where an IP44 protection degree is required. It is made with high-quality material which guarantees long-term sealing against all weather conditions.

Item	Various accessories
503CG	Protective cover for flush mounted box item 503E - to be used during finishing masonry works
503EV	Internal resin separator - for box item 503E - for the separation of data and power circuits
503EC	Finishing cover for flush mounted box item 503E - to be used when the box is used as a junction box - can be painted
504EC	Cover as above, for boxes item 504E
506EC	Cover as above, for boxes item 506E
503DE	Internal resin separator - for box item 504E
503ED	Coupling for boxes items 502E, 503E, 504E (horizontal and vertical) and for box 506L (only vertical). It cannot be used with the box extension

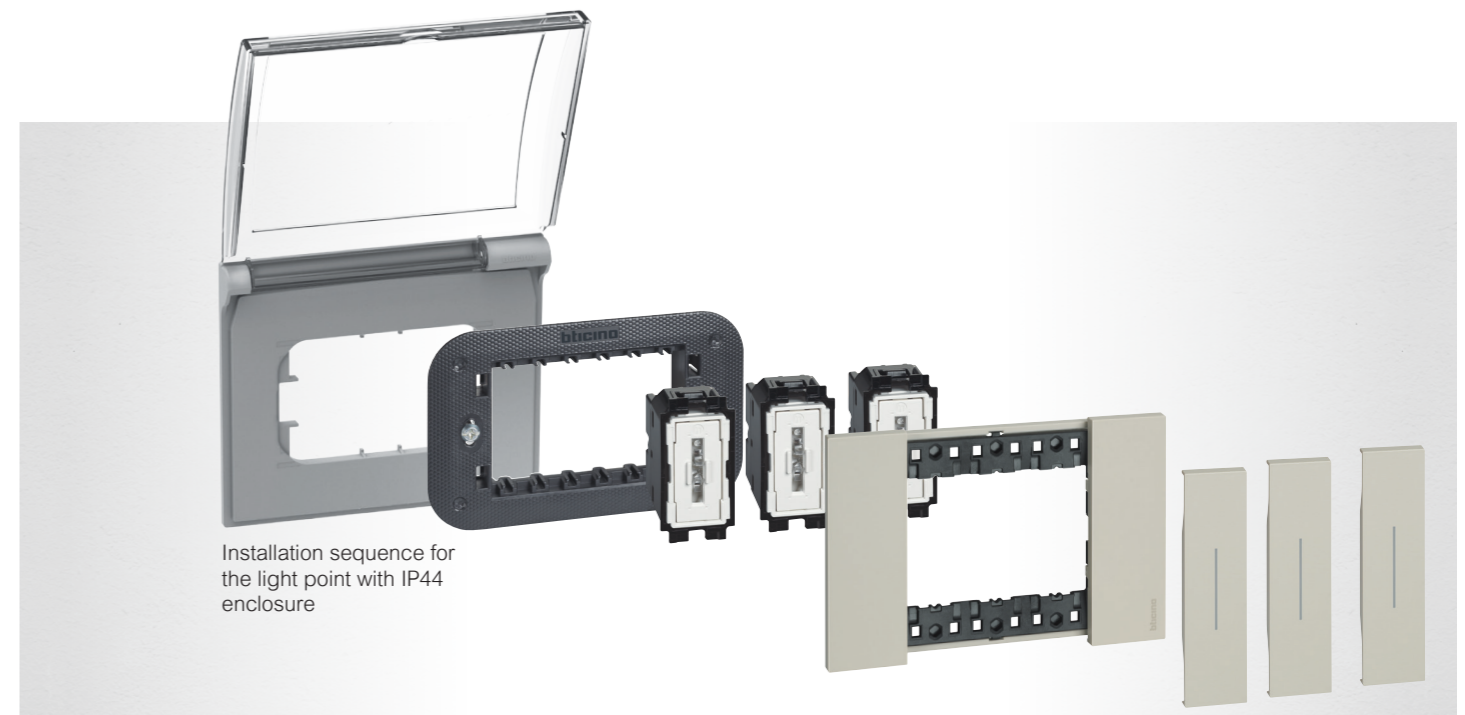



















Installation sequence for the light point with IP44 enclosure

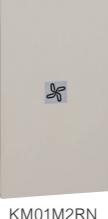

## Traditional electrical system

lightable cover with symbols, for items:  
K4001, K4003 and K4005

COVER	Item	Cover for the comand of heating, ventilation, boiler
 KW01PN  KG01PN  KM01PN	KW01PN	Cover 1 module. Heating comand White
	KG01PN	Black
	KM01PN	Sand
 KW01RN  KG01RN  KM01RN	KW01RN	Cover 1 module. Ventilation comand White
	KG01RN	Black
	KM01RN	Sand
 KW01SN  KG01SN  KM01SN	KW01SN	Cover 1 module. Boiler comand White
	KG01SN	Black
	KM01SN	Sand
 KW01M2PN  KG01M2PN  KM01M2PN	KW01M2PN	Cover 2 module. Heating comand White
	KG01M2PN	Black
	KM01M2PN	Sand
 KW01M2RN  KG01M2RN  KM01M2RN	KW01M2RN	Cover 2 module. Ventilation comand White
	KG01M2RN	Black
	KM01M2RN	Sand
 KW01M2SN  KG01M2SN  KM01M2SN	KW01M2SN	Cover 2 module. Boiler comand White
	KG01M2SN	Black
	KM01M2SN	Sand

## Living Now IoT











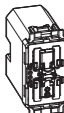

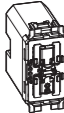
## SMART ELECTRICAL SYSTEM









Devices to be completed with appropriate cover as indicated below

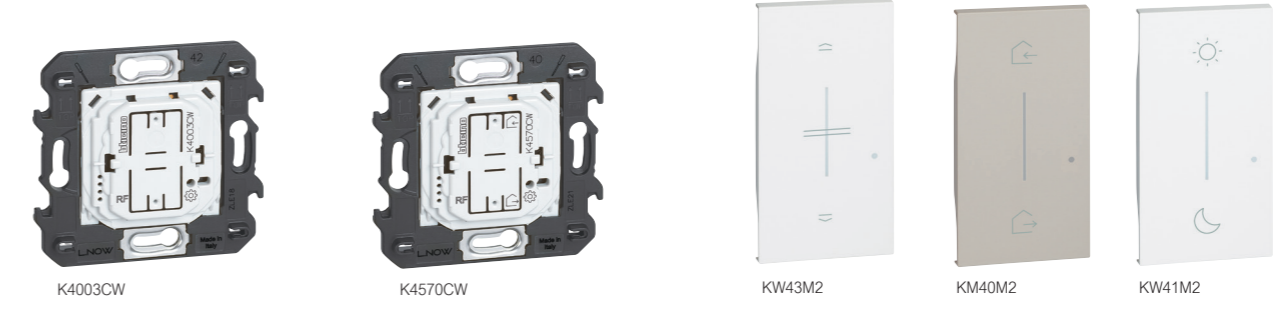



Item	Connected devices for light
○ K4003C	 <p>Connected 2ways switch. It allows to control lights locally or remotely. The connected 2ways switch has the same installation and usability of a traditional 2ways switch and it is compatible with all loads with max power 250 W. It is equipped with a blue LED light used always on for localization modality or on, when the light is on for the load status modality. It can be associated with "wireless light switches". Caution: Must be connected to the neutral. Power supply 110-230 V~ - 1 module</p>
○ 3584C	 <p>Connected lighting micromodule. It allows to control lights locally or remotely. It is compatible with all loads with max power 300 W. It can be connected to one or more traditional push-button or associated with "wireless light switches". It is installed as a traditional rele in the box (behind the button) or in derivation boxes. Caution: Must be connected to the neutral. Power supply 110-230 V~</p>
Item	Connected Dimmer/Switch
○ K4411CM2	 <p>Dimmer/switch without neutral. It allows to control lights locally or remotely, with the dimmer functionality that can be activated from APP Home+Control. It has the same installation and usability of a traditional switch and it is compatible with all loads (LED, halogen) with power 5-300 W at 230 V. It is equipped with a blue LED light used for localization modality or load status modality, configurable by APP. It can be connected associated with "wireless light switches". It doesn't require connection to the neutral, it comes with an active compensator. Power supply 110-230 V~ - 2 modules</p>
Item	Connected devices for shutters
○ K4027C	 <p>Connected rolling shutter switch - It allows the control of a shutter locally or remotely. Compatible with all standard rolling shutter motors ( with a mechanical or electromechanical stop and max power 500 VA ) controlled by a wired shutter switch (switching of the same motor power supply). Not compatible with motors for radio-controlled or pulse-controlled roller shutters. It can be associated with one or more wireless commands. Caution: Must be connected to the neutral. Power supply 110-230 V~ - 1 module</p>

Item	Cover
<input type="checkbox"/> KW01 <input checked="" type="checkbox"/> KG01 <input type="checkbox"/> KM01	<b>1 module</b>  Cover for item K4003C  Cover for item K4027C
<input type="checkbox"/> KW32 <input checked="" type="checkbox"/> KG32 <input type="checkbox"/> KM32	<b>2 modules</b>  Cover for item K4003C  Cover for item K4027C
<input type="checkbox"/> KW01M2 <input checked="" type="checkbox"/> KG01M2 <input type="checkbox"/> KM01M2	 Cover for item K4003C  Cover for item K4027C  Cover for item K4411CM2
<input type="checkbox"/> KW32M2 <input checked="" type="checkbox"/> KG32M2 <input type="checkbox"/> KM32M2	
<input type="checkbox"/> KW33M2 <input checked="" type="checkbox"/> KG33M2 <input type="checkbox"/> KM33M2	



Devices to be completed with appropriate cover as indicated below

Item	Wireless controls for light
○ K4003CW	 <p>Wireless light switch. It allows the ON / OFF and dimming control of one or more connected devices for the lighting control. Surface installation with repositionable stickers (supplied) or onto a flush mounting box. Integrated LED for low battery indication. Powered by battery 3V type CR2032 (supplied) with an autonomy of 8 years - 2 modules</p>
○ K4027CW	 <p><b>Wireless controls for shutter</b> Rolling shutter wireless switch - It allows the control of one or more connected rolling shutter switches. Surface installation with repositionable stickers (supplied) or onto a flush mounting box. Integrated LED for low battery indication. Powered by battery 3V type CR2032 (supplied) with an autonomy of 8 years - 2 modules</p>
○ K4570CW	 <p><b>Wireless Home/Away scenario controls</b> Home / Away wireless switch. It is equipped with 2 buttons for activating Home / Away scenarios. Scenarios can be customized by the Home + Control app. Surface installation with repositionable stickers (supplied) or onto a flush mounting box. Integrated LED for low battery indication. Powered by battery 3V type CR2032 (supplied) with an autonomy of 8 years - 2 modules</p>
○ K4574CW	 <p><b>Wireless Wake Up / Sleep scenario controls</b> It is equipped with 2 buttons for activating Wake Up / Sleep scenarios. Scenarios can be customized by the Home + Control app. Surface installation with repositionable stickers (supplied) or onto a flush mounting box. Integrated LED for low battery indication. Powered by battery 3V type CR2032 (supplied) with an autonomy of 8 years - 2 modules</p>

Item	Cover
<input type="checkbox"/> KW42M2 <input checked="" type="checkbox"/> KG42M2 <input type="checkbox"/> KM42M2	<b>2 module</b>  Cover for item K4003CW  Cover for item K4027CW
<input type="checkbox"/> KW43M2 <input checked="" type="checkbox"/> KG43M2 <input type="checkbox"/> KM43M2	 Cover for item K4027CW
Item	Cover
<input type="checkbox"/> KW40M2 <input checked="" type="checkbox"/> KG40M2 <input type="checkbox"/> KM40M2	<b>2 module</b>  Cover for item K4570CW
<input type="checkbox"/> KW41M2 <input checked="" type="checkbox"/> KG41M2 <input type="checkbox"/> KM41M2	 Cover for item K4574CW



App HOME + CONTROL for management of connected devices

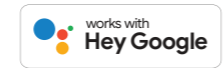

**Note:** for the use of the connected devices, the gateway, item **K4500C** item, must be installed as part of the system.

- White colour cover
- Black colour cover
- Sand colour cover
- Neutral item (without cover)
- White colour cover
- Black colour cover
- Sand colour cover
- Neutral item (without cover)





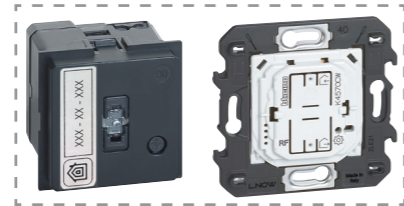

K4531C



K4500C

Devices to be completed with appropriate cover as indicated below

Item	Connected module for energy management
○ K4531C	 <p>Connected socket module - wiring to a power outlet, allows to remotely control appliances and check the consumption ( instantaneous, daily, monthly ). It is also possible to receive notifications in case of anomalous consumption. The connected socket module is compatible with any device electric and large appliances up to 16 A 3680 W max. (protected against overloads). It is equipped with a LED light lit in blue when it is on. This option can be enabled or disabled in the "Home+Control" app. It can be associated with "wireless light switches". Power supply 110-230 V~ - 1 module</p>

Item	Gateway
○ K4500C	 <p>Gateway. This pack enables to create a connected installation in the home. It can be used to control lighting, roller shutters and electrical equipment plugged into connected sockets: - using your smartphone and the Home + Control app - using voice assistants - from the general control at the entrance to your home Supplied with wireless master IN&amp;OUT scenario control, required for the association of all connected devices. Power supply 110-230 V~ - 2 modules</p>

**Cover for item K4531C**  
1 module

- KW31
- KG31
- KM31



Cover for item K4531C

**Covers required for the gateways**  
2 modules

- KW30M2
- KG30M2
- KM30M2



Cover for item K4500C in combination with the relative colored cover item KW40M2, KG40M2, KM40M2 and for item K4510C in combination with the relative colored cover item KW40, KG40, KM40.

**Cover for the gateway scenario control**  
2 modules

- KW40M2
- KG40M2
- KM40M2



Cover for item K4570CW (scenario control supplied with the gateway item K4500C)



XW8002



XG8002



XM8002







XW8002W

The Smarther connected thermostat, together with the dedicated HOME+CONTROL APP, is a device which allows you to adjust and monitor the temperature in the rooms precisely and accurately; all the programming and most of the functions are performed simply and intuitively using the APP. Thanks to its Wi-Fi connection, Smarther can be programmed and controlled remotely; it can also display the temperature and humidity measured in the room. The temperature level can be set locally for manual operation and the Boost mode can be activated. The Boost forces the switching on of the system for a limited time (30, 60 or 90 minutes) independent of the measured and programmed temperature. It's also possible to set a different temperature in each room of the house for the maximum comfort, thanks to its compatibility smart radiator valves. Smarther can also be controlled with Google, Amazon Alexa and Apple Home Kit voice assistants.

- Features:
- 110 ÷ 230 V~, 50/60 Hz power supply;
  - 2 W max absorption;
  - maximum cable section 1 x 1.5mm<sup>2</sup>;
  - temperature measurement 5 ÷ 40°C;
  - temperature set-point 5 ÷ 40°C;
  - increase of 0.5°C;
  - 1-contact output in switching free of potential 5(2)A.

- Types of installation:
- flush mounted, on boxes item 503E or 500 (for item 500 use the wall dowels)
  - plasterboard, on boxes 2 module and 3 module

It is available in three colours: white (XW8002), sand (XM8002) and black (XG8002).

Item	Connected thermostats
<input type="checkbox"/> XW8002	 White  Black  Sand
<input checked="" type="checkbox"/> XG8002	
<input type="checkbox"/> XM8002	
XW8002W	 <p>Features: as XW8002. Installation on the wall, using screws and dowels suitable for the installation surface (brickwork, plasterboard, tiles etc.). It is only available in white.</p>



App HOME + CONTROL for management of connected devices

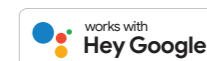



# Living Now

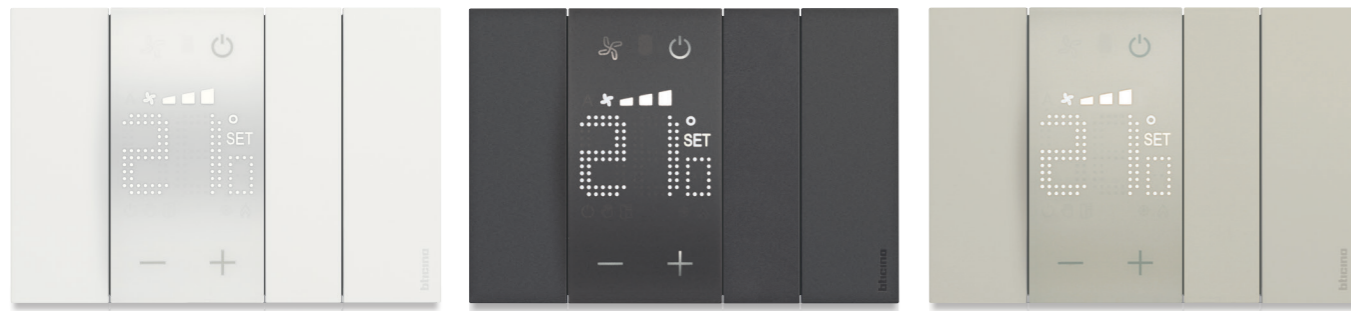

## MyHOME\_Up system



**Item** **Control server using the app**

○ MYHOMESERVER1  Server to associate devices during the system starting-up and for the local and remote management of the functions by the user with the specific MyHOME\_Up application for Android and iOS smartphones or tablets.

**Item** **SCS/DALI interface**

○ F429  DALI dimmer, 8 independent outputs with maximum load 16 ballast at 230 Vac, pushbutton for load direct control - 6 DIN modules

○ MHSERVERKIT **MyHOMEServer1 KIT**  Kit containing MyHOMEServer1 and Access Point for communication between the MyHome\_Up system to which it is connected, and a smartphone or tablet where the MyHome-Up App is installed.

○ F459 **Driver manager**  Integration platform with other brand systems - 6 DIN modules

**Note:** For the details of the products managed by MyHome\_Up and the compatible products, see the corresponding guide.

Contact the Legrand System Integration Service to check the feasibility of specific integrations and to request the licence needed to use the Driver manager (Toll free number 800.837035)

○ 3487 **Box for flush mounted installation**  Box for flush mounted installation of the HOMETOUCH Touch screen item 3488 and 3488W. Width 197 mm, height 148 mm and depth 52 mm.

○ 3487AP  Support for flush mounted installation on plasterboard walls of the HOMETOUCH Touch screen item 3488 and 3488W.

**App MyHOME\_Up**  Mobile device App that allows:  
- the installer, thanks to a self-learning procedure, to easily associate the devices together when starting up the system;  
- the user to manage his home home-automation wherever he is.







**Voice control**

Item:  KW8013,  KG8013,  KM8013

Amazon Alexa digital control device with voice assistant, including two touch controls for lighting management. 27 Vd.c. power supply from BUS through connection module item KW8001 or additional power supply unit, item K8003 - 3 modules

**Power supply**

Item:  K8003

Connection module with additional power supply dedicated to Voice control Alexa built-in item KW/KG/KM8013 - 2 modules

**Light control**

Item:  KW8010,  KG8010,  KM8010

Touch control for the management of ON/OFF light functions. One single control can manage from 1 to 2 functions between single lights, light groups or general lights. - 1 module

**Full control**

Item:  KW8011,  KG8011,  KM8011

Touch control for the management from 1 to 3 functions between: lights on/off, load control, dimmer, shutters up/down with or without preset, NUVO Player and scenarios. It can also be used as group or general control. It has on-board proximity sensor that allows the display of function icons/symbols when approaching the control - 1 module

**ON/OFF actuators for lights and for shutters**

Item:  K8002L,  K8002S

Flush-mounted actuator with 2 independent and neutral relays for "zero crossing" function - single or double 230 V~ loads - 1 module

Flush-mounted shutter actuator with 2 independent relays. It allows the management of a specific shutter position. Through the control KW/KG/KM8011, together with the UP/DOWN function monostable and bistable, the actuator also places the shutter in a stored (PRESET) position - 1 module

**Connection modules**

Item:  K8001

Device for the power supply of controls and actuators through electrified frame item KW/KG/KM8103 KW/KG/KM8103P1 KW/KG/KM8104 KW/KG/KM8104P1 KW/KG/KM8102P1

**Blanking module**

Item:  KW8100,  KG8100,  KM8100

Cover for blanking module art. K4950 - 1 module

**Electrified frames for 3 and 4 module boxes**

Item:  KW8103,  KG8103,  KM8103

Electrified frame with intermediate control separators (removable). For the installation of up to 3 digital controls or covers, item KW/KG/KM8100 in 3-module box with support K4703

Item:  KW8103P1,  KG8103P1,  KM8103P1

Electrified frame with intermediate control separators (removable). For the installation of up to 4 digital controls or covers, item KW/KG/KM8100 in 3-module box with support K4703

Item:  KW8104,  KG8104,  KM8104

Electrified frame with intermediate control separators (removable). For the installation of up to 4 digital controls or covers, item KW/KG/KM8100 in 4-module box with support K4704

Item:  KW8104P1,  KG8104P1,  KM8104P1

Electrified frame with intermediate control separators (removable). For the installation of up to 5 digital controls or covers, item KW/KG/KM8100 in 4-module box with support K4704

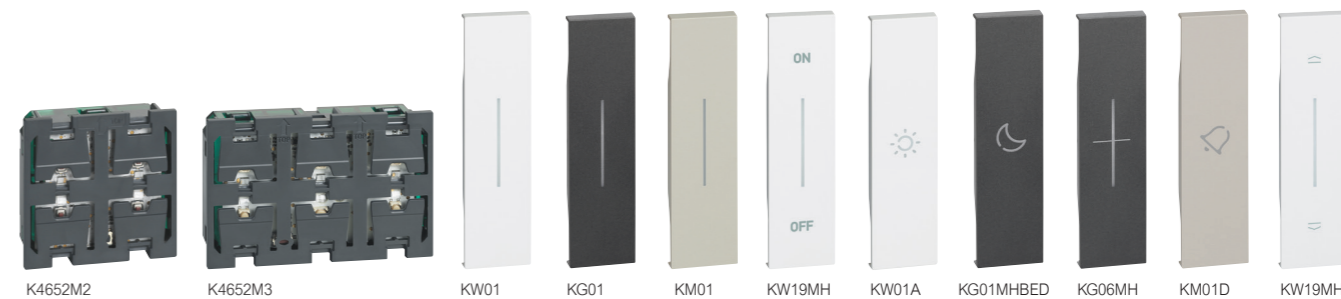

Devices to be completed with appropriate cover as indicated below

**Control devices**

Item:  K4652M2,  K4652M3

Control for the management of one or two ON/OFF functions, the shutter UP/DOWN function and the adjustment of a dimmer load. It can also be used as scenario control and for the call to the floor, staircase light switching on and door lock activation functions. It manages advanced shutter functions. - 2 modules. To be completed with 1 or 2-module covers.

Control for the management of up to three separate functions as described above - 3 modules. To be completed with 1 or 2-module covers.

**Actuator/control for lights and generic loads**

Item:  K4672M2L

Actuator/control with 2 independent relays for single or double loads: The device can be also configured to manage a remote actuator with the same functions of the K4652M2 and K4652M3 controls - 2 modules. To be completed with 1 or 2-module covers.

**Actuator/control for shutter**

Item:  K4672M2S

Shutter actuator with 2 internal relay 2 A 250 V~. In addition to the monostable and bistable UP/DOWN function, the actuator also places the rolling shutter in a stored (PRESET) position. The device can be also configured to manage a remote actuator - 2 modules. To be completed with 1 or 2-module covers.

**Cover without symbols**

Item:  KW01,  KG01,  KM01

**1 module**

Lightable cover for item K4652M2, K4652M3 and K4672M2L

**2 modules**

Lightable cover for item K4652M2 and K4672M2L

Lightable cover high brightness for item K4652M2 and K4672M2L

Actuators	LOADS THAT CAN BE DRIVEN (230 V~ 50/60 Hz)						
	Type						
	Energy saving incandescence and halogen lamps	LED lamps	Linear fluorescent lamps <sup>1)</sup>	Compact fluorescent lamps	Electronic transformers <sup>3)</sup>	Ferromagnetic transformers <sup>2) 3)</sup>	Reducer motors for shutters <sup>4)</sup>
K4672M2L	1380 W	250 W Max 2 lamps	250 VA	250 W Max 2 lamps	460 W	460 VA	460 W
K4672M2S	-	-	-	-	-	-	2 A 250 Va.c.

**Notes:**

1) Power factor corrected fluorescent lamps, discharge lamps.  
 2) Account must be taken of the transformer yield to calculate the effective power of the load connected to the actuator. For example if a dimmer is connected to a 100 VA ferromagnetic transformer with yield 0.8, the effective power of the load will be 125 VA.  
 3) The transformer must be loaded at its rated power and however never less than 90% of this power. It is preferable to use a single transformer rather than several transformers in parallel. For example it is better to use a single 250 VA transformer with 5 50W spotlights connected rather than use 5 50 VA transformers in parallel each with a 50 W spotlight.  
 4) The symbol on the actuators refers to the shutter reducer motors.

White colour cover     Black colour cover     Sand colour cover     Neutral item (without cover)





Devices to be completed with appropriate cover as indicated below

Item	Cover with symbols
<ul style="list-style-type: none"> <li><input type="checkbox"/> KW01MHAG</li> <li><input checked="" type="checkbox"/> KG01MHAG</li> <li><input type="checkbox"/> KM01MHAG</li> </ul>	<p><b>1 module</b> Lighttable cover for item K4652M2, K4652M3 and K4672M2L</p> <p>ON/OFFfunction silk-screen printing</p>
<ul style="list-style-type: none"> <li><input type="checkbox"/> KW19MH</li> <li><input checked="" type="checkbox"/> KG19MH</li> <li><input type="checkbox"/> KM19MH</li> </ul>	<p>- + and - silk-screen printing for dimmer</p>
<ul style="list-style-type: none"> <li><input type="checkbox"/> KW01MHBED</li> <li><input checked="" type="checkbox"/> KG01MHBED</li> <li><input type="checkbox"/> KM01MHBED</li> </ul>	<p>BED symbol</p>
<ul style="list-style-type: none"> <li><input type="checkbox"/> KW01MHGEN</li> <li><input checked="" type="checkbox"/> KG01MHGEN</li> <li><input type="checkbox"/> KM01MHGEN</li> </ul>	<p>GOING OUT symbol</p>
<ul style="list-style-type: none"> <li><input type="checkbox"/> KW01MHBACK</li> <li><input checked="" type="checkbox"/> KG01MHBACK</li> <li><input type="checkbox"/> KM01MHBACK</li> </ul>	<p>COMING IN symbol</p>
<ul style="list-style-type: none"> <li><input type="checkbox"/> KW01D</li> <li><input checked="" type="checkbox"/> KG01D</li> <li><input type="checkbox"/> KM01D</li> </ul>	<p>BELL symbol</p>
<ul style="list-style-type: none"> <li><input type="checkbox"/> KW06MH</li> <li><input checked="" type="checkbox"/> KG06MH</li> <li><input type="checkbox"/> KM06MH</li> </ul>	<p>Lighttable cover for item K4652M2, K4652M3 and K4672M2S</p> <p>STOP symbol silk-screen printing for shutters</p>

Item	Cover with symbols
<ul style="list-style-type: none"> <li><input type="checkbox"/> KW01MH2AG</li> <li><input checked="" type="checkbox"/> KG01MH2AG</li> <li><input type="checkbox"/> KM01MH2AG</li> </ul>	<p><b>2 modules</b> Lighttable cover for item K4652M2 and K4672M2L</p> <p>ON/OFFfunction silk-screen printing</p>
<ul style="list-style-type: none"> <li><input type="checkbox"/> KW19MH2</li> <li><input checked="" type="checkbox"/> KG19MH2</li> <li><input type="checkbox"/> KM19MH2</li> </ul>	<p>- + and - silk-screen printing for dimmer</p>
<ul style="list-style-type: none"> <li><input type="checkbox"/> KW01MH2A</li> <li><input checked="" type="checkbox"/> KG01MH2A</li> <li><input type="checkbox"/> KM01MH2A</li> </ul>	<p>LIGHT/WAKE UP symbol</p>
<ul style="list-style-type: none"> <li><input type="checkbox"/> KW01MH2BED</li> <li><input checked="" type="checkbox"/> KG01MH2BED</li> <li><input type="checkbox"/> KM01MH2BED</li> </ul>	<p>BED symbol</p>
<ul style="list-style-type: none"> <li><input type="checkbox"/> KW01MH2GEN</li> <li><input checked="" type="checkbox"/> KG01MH2GEN</li> <li><input type="checkbox"/> KM01MH2GEN</li> </ul>	<p>GOING OUT symbol</p>
<ul style="list-style-type: none"> <li><input type="checkbox"/> KW01MH2BACK</li> <li><input checked="" type="checkbox"/> KG01MH2BACK</li> <li><input type="checkbox"/> KM01MH2BACK</li> </ul>	<p>COMING IN symbol</p>
<ul style="list-style-type: none"> <li><input type="checkbox"/> KW01MH2D</li> <li><input checked="" type="checkbox"/> KG01MH2D</li> <li><input type="checkbox"/> KM01MH2D</li> </ul>	<p>BELL symbol</p>
<ul style="list-style-type: none"> <li><input type="checkbox"/> KW01MH2F</li> <li><input checked="" type="checkbox"/> KG01MH2F</li> <li><input type="checkbox"/> KM01MH2F</li> </ul>	<p>KEY symbol</p>
<ul style="list-style-type: none"> <li><input type="checkbox"/> KW05MH2</li> <li><input checked="" type="checkbox"/> KG05MH2</li> <li><input type="checkbox"/> KM05MH2</li> </ul>	<p>Lighttable cover for item K4652M2 and K4672M2S</p> <p>UP/DOWN silk-screen printing</p>

White colour cover     Black colour cover     Sand colour cover     Neutral item (without cover)



Item	Light control/actuator
○ 3476	1 relay actuator - for single loads: 2 A resistive or incandescence lamps, 2 A cosφ 0.5 for ferromagnetic transformers - a traditional pushbutton with NO contact accepted in input
○ F411U2	<b>Actuators for centralisations</b> Actuator with 2 independent relays – for single and double loads: 10 A resistive and 6 A incandescence lamps, 500 W for reducer motors, 2 A cosφ 0.5 for ferromagnetic transformers and 250 W for fluorescent lamps - logic relay interlock via configuration - it has "Zero crossing" technology - 2 DIN modules
○ F411/4	Actuator with 4 independent relays - for single, double or mixed loads: 2 A resistive, 2 A incandescence lamps, 500 W for reducer motors, 2 A cosφ 0,5 for ferromagnetic transformers and 70 W for fluorescent lamps - logic relay interlock via configuration - 2 DIN modules

Item	Actuators for centralisations
○ BMSW1003	ON/OFF actuator, 4 independent outputs with maximum load 16 A at 230 V a.c., clamp connection and RJ45, IP20 protection index, power supply 100/240 Va.c. 50/60 Hz, pushbuttons for load direct control - zero-crossing function - 6 DIN modules
○ BMSW1005	ON/OFF actuator, "Zero Crossing" technology, 8 independent outputs with maximum load 16 A at 230 V a.c., clamp connection, IP20 protection index, power supply 100/240 V a.c. 50/60 Hz, pushbuttons for load direct control - 10 DIN modules
○ F401	Actuator with 2 internal relays and 4 pushbuttons. In addition to monostable and bistable UP/DOWN operation, the actuator also places the shutter in a stored (PRESET) position - 2 DIN modules

Actuators	LOADS THAT CAN BE DRIVEN (250 V~ 50/60 Hz)						
	Type						
<b>3476</b>	2 A 460 W	40 W Max 1 lamp	- -	40 W Max 1 lamp	- -	2 A cosφ 0,5 460 VA	- -
<b>F411U2</b>	10 A 1380 W	250 W Max 4 lamps	4 A 230 W	250 W Max 4 lamps	4 A 230 W	4 A cosφ 0,5 460 VA	2 A 460 W
<b>F411/4</b>	2 A 460 W	70 W Max 2 lamps	0.3 A 70 W	70 W Max 2 lamps	0.3 A 70 W	2 A cosφ 0,5 460 VA	2 A 460 W
<b>BMSW1003</b>	16 A 3680 W	2.1 A 500 VA	10 X (2 X 36 W) 4.3 A	1150 W 5 A	16 A 3680 W	16 A 3680 W	- -
<b>BMSW1005</b>	16 A 3680 W	2.1 A 500 VA	4.3 A 10X2X36 W	5 A 1150 VA	16 A 3680 W	16 A 3680 W	- -
<b>F401</b>							2 A 250 Va.c.

**Notes:**  
 1) Power factor corrected fluorescent lamps, discharge lamps.  
 2) Account must be taken of the transformer yield to calculate the effective power of the load connected to the actuator. For example if a dimmer is connected to a 100 VA ferromagnetic transformer with yield 0.8, the effective power of the load will be 125 VA.  
 3) The transformer must be loaded at its rated power and however never less than 90% of this power. It is preferable to use a single transformer rather than several transformers in parallel. For example it is better to use a single 250 VA transformer with 5 50W spotlights connected rather than use 5 50 VA transformers in parallel each with a 50 W spotlight.  
 4) The symbol on the actuators refers to the shutter reducer motors.

White colour cover     Black colour cover     Sand colour cover     Neutral item (without cover)

Items in red colour: New products



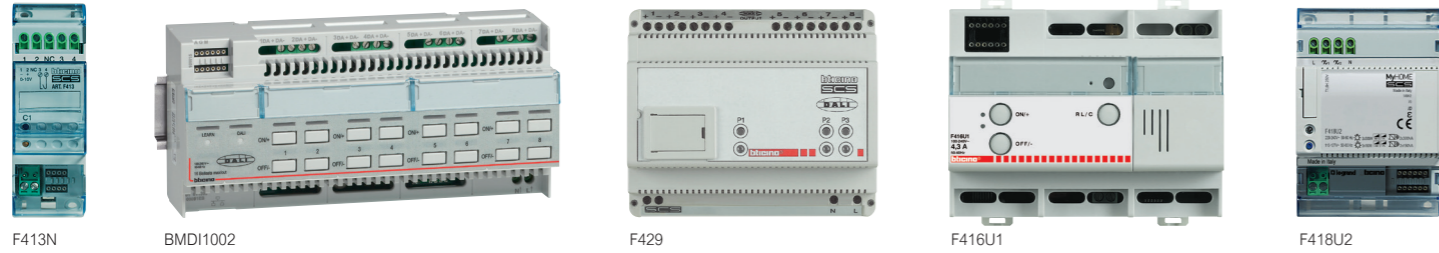

- Dimmers for centralisations**
- F413N: 1-output dimmer to supply fluorescent lamps or LED sources with input 1-10 V for single loads up to 2.5 A at 230 V a.c. – type of screw connection - power supply 27 Vd.c. – absorption 30 mA – max 10 ballast that can be connected (clamps 1-2) - with pushbutton for load direct control - version for fastening on DIN rail - 2 modules
  - BMD11002: 1/10V dimmer, "Zero Crossing" technology, 4 outputs with maximum load 4.3 A at 230 V a.c., clamp connection, IP20 protection index, power supply 100/240 V a.c. 50/60 Hz, pushbuttons for load direct control - 10 DIN modules
  - F429: DALI dimmer with 8 independent outputs for the connection of up to 16 DALI reactors for each output – 230 V a.c. power supply 50/60 Hz; 110 - 240 Vd.c. – absorption 5 mA - with pushbutton for load direct control - version for fastening on DIN rail - 6 modules

- Multi-load dimmers for centralisations**
- F416U1: Multi-load dimmer, 1 output with maximum load 4.3 A at 230 V a.c., clamp connection and RJ45, IP20 protection index, power supply 100/240 V a.c. 50/60 Hz, pushbutton for load direct control - 6 DIN modules
  - F418U2: Two-channel dimmer for the management of dimmer LEDs, dimmer compact fluorescent lamps (CFL), energy saving halogen lamps and electronic transformers at 110-230V. Possibility of parallelisation of the two channels to increase the maximum power which can be managed. power supply 27 Vd.c., absorption 18 mA - version for fastening on DIN rail - 4 modules

LOADS THAT CAN BE DRIVEN (230 V~ 50/60 HZ)							
Actuators	Type						
	Energy saving incandescence and halogen lamps	LED lamps	Linear fluorescent lamps <sup>1)</sup>	Compact fluorescent lamps	Electronic transformers <sup>3)</sup>	Ferromagnetic transformers <sup>2) 3)</sup>	Reducer motors for shutters <sup>4)</sup>
<b>BMD11002</b>	Dimmer for ballast - 4 x 4.3 A outputs - 4x 1000VA@ 230 Vac - 4x500VA@ 230 Vac						
<b>F413N</b>	-	-	2 A 460 W <sup>5)</sup> Max 10 ballast, type T5, T8, compact or driver for LED	-	-	-	-
<b>F414</b>	0.25 - 4.3 A 60 - 1000 VA	-	-	-	-	0.25 - 4.3 A 60 - 1000 VA	-
<b>F416U1</b>	4.3 A	-	-	-	4.3 A	4.3 A	-
<b>F418U2</b>	2x300 W	2x300 VA	-	2x300 VA	2x300 VA	2x300 VA	-
<b>F429</b>	SCS/DALI dimmer interface - 8 x16 ballast						

- Notes:**
- 1) Power factor corrected fluorescent lamps, discharge lamps. 2) Account must be taken of the transformer yield to calculate the effective power of the load connected to the actuator. For example if a dimmer is connected to a 100 VA ferromagnetic transformer with yield 0.8, the effective power of the load will be 125 VA.
  - 3) The transformer must be loaded at its rated power and however never less than 90% of this power. It is preferable to use a single transformer rather than several transformers in parallel. For example it is better to use a single 250 VA transformer with 5 50W spotlights connected rather than use 5 50 VA transformers in parallel each with a 50 W spotlight.
  - 4) The symbol on the actuators refers to the shutter reducer motors.
  - 5) Only compatible with lamps with 1/10 V ballast.

□ White colour cover    ■ Black colour cover    □ Sand colour cover    ○ Neutral item (without cover)



Devices to be completed with appropriate cover as indicated below

- Thermostat**
- KW4691: White
  - KG4691: Black
  - KM4691: Sand
- Probe with backlit display that controls the temperature of an individual zone. It features an input for the connection of a contact line (e.g. window contact). It can be used for the management of different types of systems, and the adjustment of the fan speed when fan coils are used. Possibility of automatic operation (summer/winter), with compatible systems - 2 modules

- Probe without display**
- 3454: Temperature probe in basic module with wired sensor - to be associated to the temperature sensor item 3457 and Vantage probe item 8051
- Accessories**
- 3457: Temperature probe to be associated to the probe item 3454

- Actuators**
- F430/2: Actuator with 2 independent relays – for single and double loads: 6 A resistive, 2A motor driven valves and pumps - configuration based logic relay interlock - 2 DIN modules
  - F430/4: Actuator with 4 independent relays - for single, double or mixed loads: 4 A resistive, 1 A motor driven valves, pumps and fan coils - configuration based logic relay interlock - 2 DIN modules
  - F430R8: Actuator with 8 independent relays for the control of on-off valves, motorised valves (open-close and three points), pumps and fan coils with 2 and 4 tubes - 4A resistive, 1A motor valves, pumps and fan-coils- SCS-bus connection - 4 DIN modules
  - F430R3V10: Actuator with 3 independent relays and 2 x 0-10 Volts outputs for the control of fan coils with 2 and 4 tubes with proportional 0-10 Volt valves - 4A resistive, 1A fan coil - SCS-BUS connection - 4 DIN modules
  - F430V10: Actuator with 2 x 0-10 Volt outputs for the control of 0-10 proportional valves - SCS-BUS connection - 2 DIN modules

□ White colour cover    ■ Black colour cover    □ Sand colour cover    ○ Neutral item (without cover)



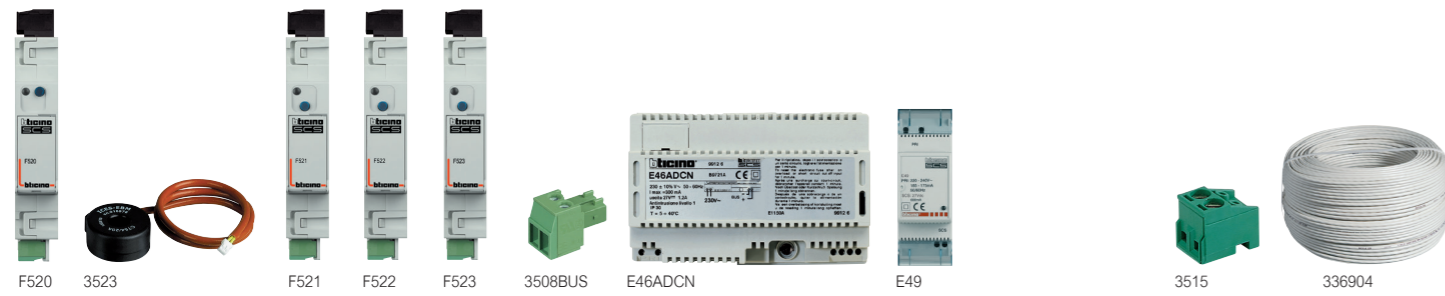

Item	Consumption display
○ F520	Meter for the measurement of electricity on a maximum of 3 lines, by connecting 3 toroids to the appropriate inputs. Version for fastening on DIN rail - 1 module. The device is fitted with 1 toroid.
○ 3523	Additional electricity meter toroid, item F520 and for actuator with sensor, item F522 for the measurement of the earth leakage current. Cable length 400 mm.

Item	Load control management
○ F521	Central unit for the management and control of the actuators of the load control system, to prevent the risk of detachment of the limiter of the electricity supplier. The central unit manages up to 63 loads, a contract power between 1.5 and 18 kW, and tolerance up to +/- 20%. It integrates an electricity meter for the controlled line. Version for fastening on DIN rail - 1 module. The device is fitted with 1 toroid.
○ F522	Actuator with integrated current sensor for the measurement of the controlled load consumptions. 1 relay - 10 A for incandescence lamps and 4 A for fluorescent lamps or ferromagnetic transformers, and 500 for compact fluorescent and LED lamps - Bistable relay with zero crossing for the Automation and/or Load control management functions. Version for fastening on DIN rail - 1 module. Earth leakage control by connecting the additional toroid, item 3523.
○ F523	1 relay actuator - for incandescence lamps and 4 A for fluorescent lamps or ferromagnetic transformers, and 500 W for compact fluorescent and LED lamps - bistable relay with zero crossing for the Automation and/or Load control management functions. Version for fastening on DIN rail - 1 module.

Item	Accessories
○ 3508BUS	removable clamp for BUS connection - width 3.81 mm
○ 3508U2	removable clamp 2 poles
○ 3508U3	removable clamp 3 poles

Item	Power supplies
○ E46ADCN	Power supply - input 230 Va.c. output 27 Vd.c. SELV - maximum absorbed current 450mA - installation on DIN profile for flush mounted or wall-mounted switchboards - 8 DIN modules
○ E49	Compact power supply - input 230 Va.c. - output 27 Vd.c. Maximum current delivered 600 mA - 2 DIN modules.

Item	Various accessories
○ 3515	spare removable clamp

Item	Connection cables
○ L4669	Sheathed pair made up of 2 flexible wires with unshielded plaited sheath - insulation 300/500 V - complies with standards CEI 46-5 and CEI 20-20 - coil length 100 metres
○ L4669/500	as above - in 500 m coils
○ L4669KM1	As above - reel length 1000 m (1)
○ 336905	As above - low toxicity cable without halogens - ideal for application in environments where fire hazard safety is critical - coil length 200 metres
○ 336904	Specific cable with 2 twisted conductors. It can be installed in underground piping, in accordance with standards (CEI 20-13 and CEI 20-14). It ensures the best performance in video systems (higher distance between EP and Handset when compared with other cables). 200 m coil

System	Cable	
	L4669 - L4669/500	336904
	L4669KM1 - 336905	

Automation	•	•(1)
Energy Management/Consumption Display	•	•(1)
Temperature control	•	•(1)
Video door entry system		•

NOTE (1): for systems underground cable sections















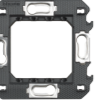



## Living Now

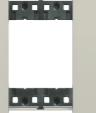

## INSTALLATION AND COVER PLATE RANGE

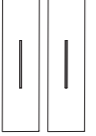
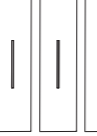

SELECTION TABLE

	2 modules	3 modules	4 modules	6 modules
Metal Flush boxes	 502MT	 503MT	 504MT	 506LMT
Supports	 K4702 (*)	 K4703 with screws	 K4704 with screw	 K4706 with screw
No. of function modules	 2 modules	 3 modules	 4 modules	 6 modules
Living Now cover plates	 KA4802...	 KA4803...	 KA4804...	 KA4806...
No. of 1-module covers required for the completion of the light point	 2 covers	 3 covers	 4 covers	 6 covers

\* Note: supplied without screws. Fastening using the screws supplied with boxes 502E and PB502N.

PROTECTED INSTALLATIONS

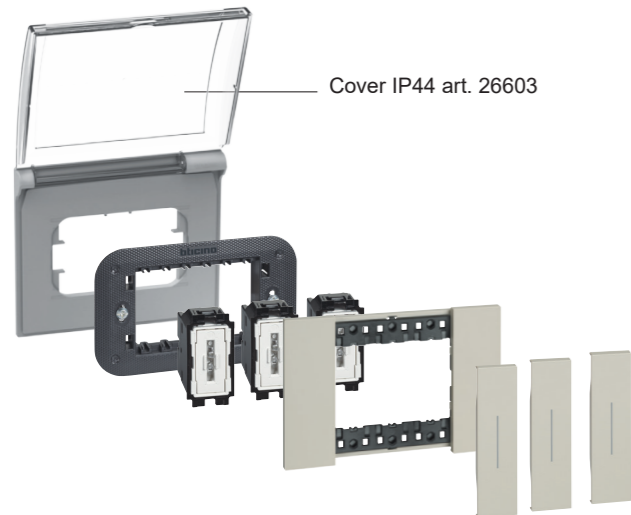

- Note: protective shell supplied with supports, available in all modularities.

- To be used:
- at the site, before the installation of cover plates and covers
  - after removing cover plates and covers when painting the walls

EXAMPLE OF INSTALLATION OF THE LIGHT POINT WITH 1-MODULE COVER

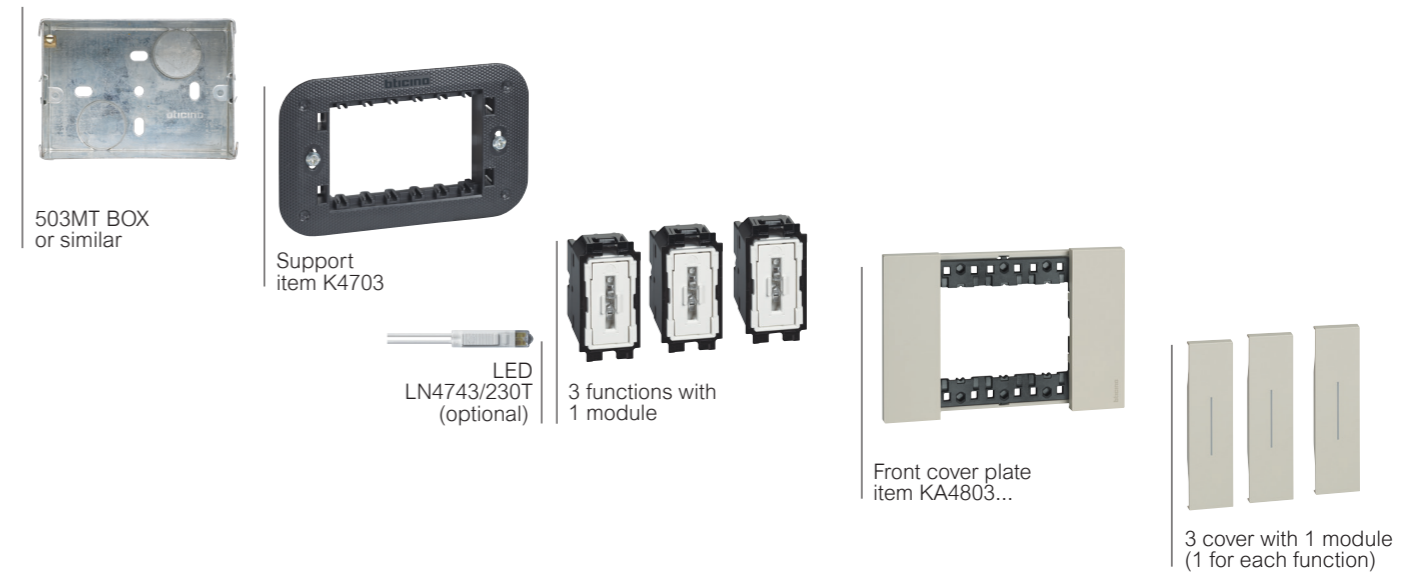

EXAMPLE OF LIGHT POINT COMPOSITION

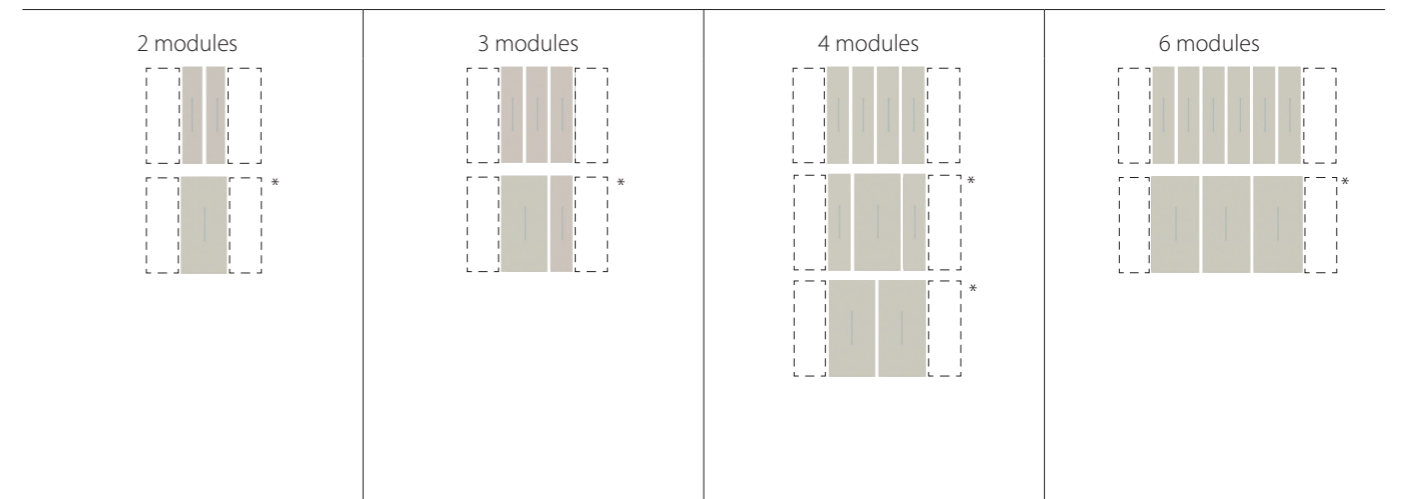

\* Note: for solutions using one 2-module cover for the main controls, it will be necessary to use two "half-module blanking modules" (item K4949) at the sides of the control. (see the sample diagrams below)

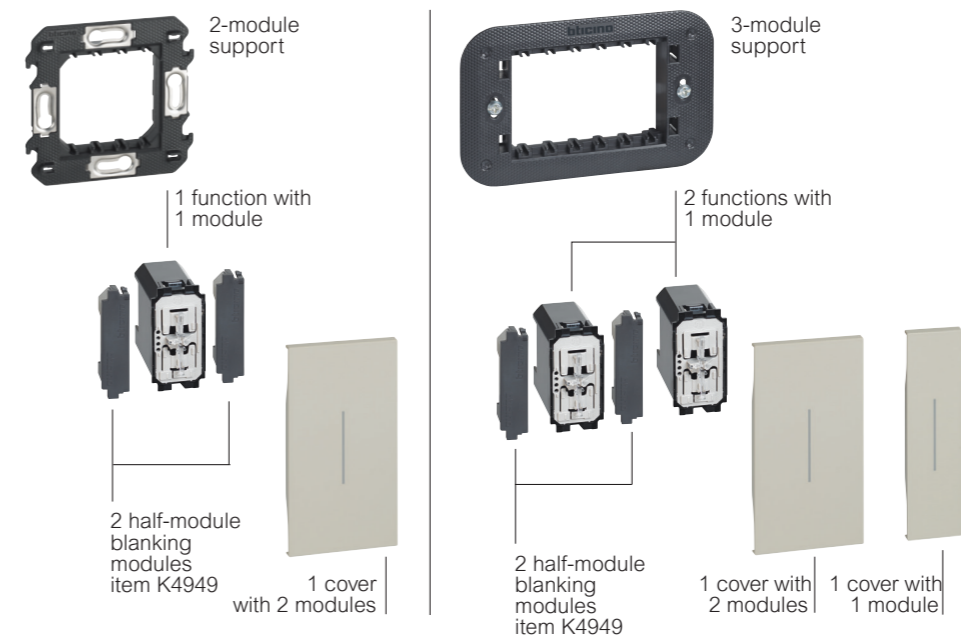



Living Now  
Indian standard installation - range of cover plates - 1 module installation

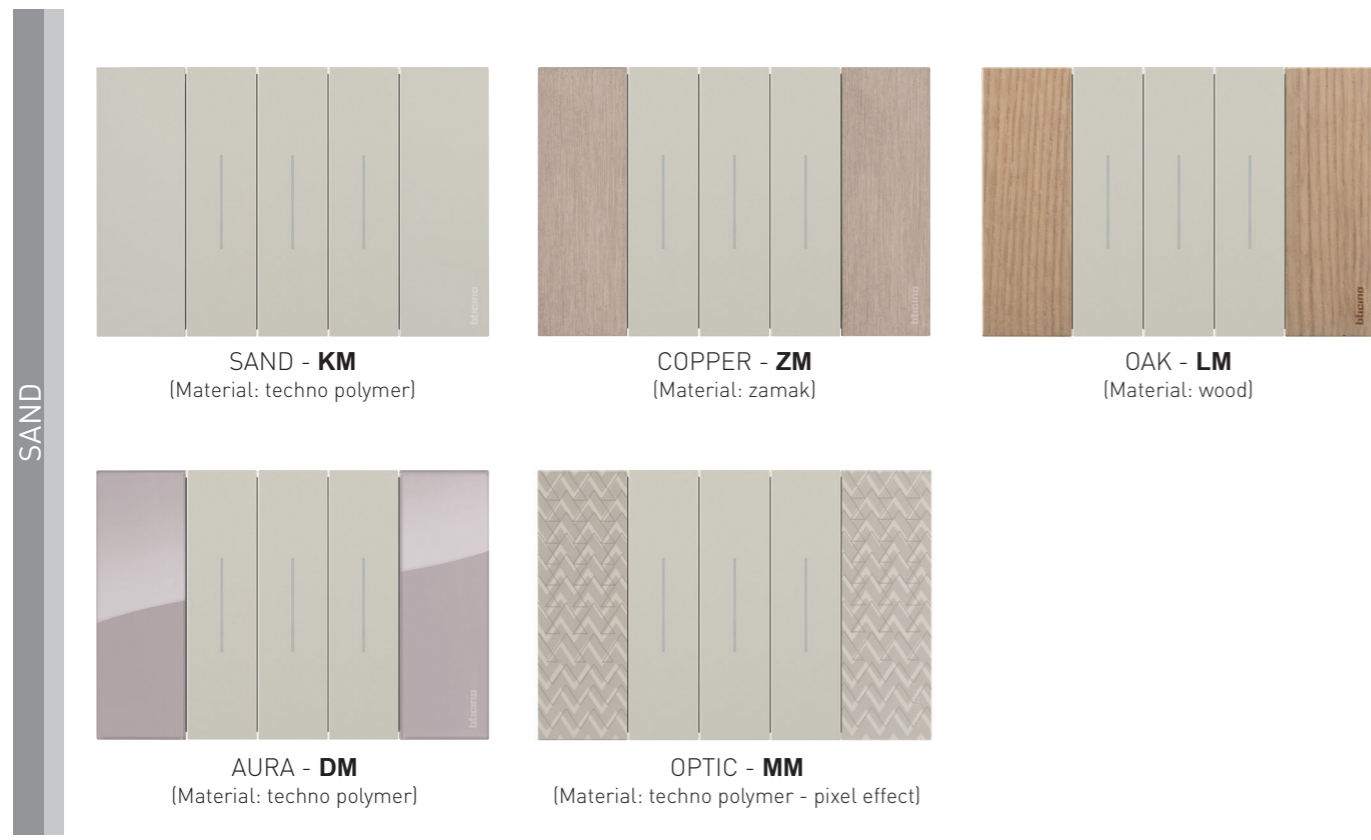

**Notes:**  
- The cover plate/cover combinations shown in these pages are purely indicative. Each cover plate can in fact be combined with covers of any colours, as required by the customer (white, sand and black).  
- The zamak and wood finishes are obtained using non-mass production procedures. The differences among the various cover plates are therefore a distinguishing valuable element.

Living Now  
Indian standard installation - range of cover plates - 1 module installation

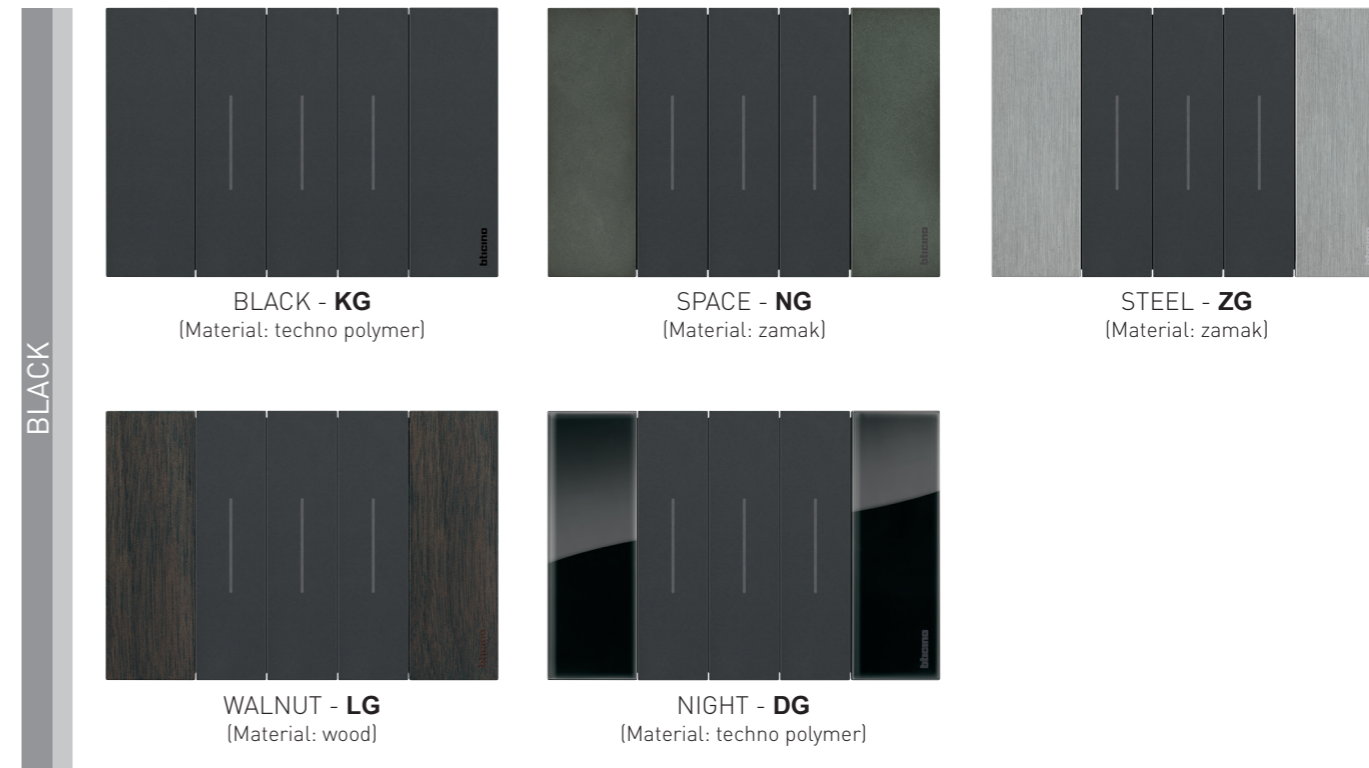











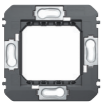







SELECTION TABLE

Finish	2 modules		3 modules		4 modules		6 modules	
	Icon	Code	Icon	Code	Icon	Code	Icon	Code
WHITE		KA4802KW		KA4803KW		KA4804KW		KA4806KW
GOLD		KA4802ZW		KA4803ZW		KA4804ZW		KA4806ZW
MOON		KA4802NW		KA4803NW		KA4804NW		KA4806NW
ICE		KA4802DW		KA4803DW		KA4804DW		KA4806DW
SKY		KA4802DA		KA4803DA		KA4804DA		KA4806DA
PIXEL		KA4802MW		KA4803MW		KA4804MW		KA4806MW
SAND		KA4802KM		KA4803KM		KA4804KM		KA4806KM
COPPER		KA4802ZM		KA4803ZM		KA4804ZM		KA4806ZM
OAK		KA4802LM		KA4803LM		KA4804LM		KA4806LM
AURA		KA4802DM		KA4803DM		KA4804DM		KA4806DM
OPTIC		KA4802MM		KA4803MM		KA4804MM		KA4806MM
BLACK		KA4802KG		KA4803KG		KA4804KG		KA4806KG
SPACE		KA4802NG		KA4803NG		KA4804NG		KA4806NG
STEEL		KA4802ZG		KA4803ZG		KA4804ZG		KA4806ZG
WALNUT		KA4802LG		KA4803LG		KA4804LG		KA4806LG
NIGHT		KA4802DG		KA4803DG		KA4804DG		KA4806DG
Supports		K4702		K4703		K4704		K4706

COMPOSITION OF DIGITAL CONTROLS

For each type of box, the electrified frames used and the number of devices and the accessories that can be installed are indicated.

	2 modules	3 modules	4 modules		
Metal flush boxes	 502MT	 503MT	 504MT		
Supports	 K8102	 K4703 with screws	 K4704 with screws		
Flush mounted boxes - connection module K8001; - actuators K8002L and e K8002S; - additional power supply K8003 (2 modules).		 3 modules	 4 modules		
Blanking module K4950		 max. 2 blanking modules	 max. 3 blanking modules		
Electrified frame	 3 modules ..8102P1	 3 modules ..8103	 3+1 modules ..8103P1	 4 modules ..8104	 4+1 modules ..8104P1
Voice control item ..8013 (3 modules) Digital control Light item ..8010 and Full item ..8011 Cover for blanking module item 4950					

WARNING FOR THE SELECTION OF THE DEVICES:

- Note (\*) The connection module is necessary; its position is free inside the box.
- If the installation of the additional power supply, item K8003, is required for the voice command, item ....8013 (see the MyHOME\_Up guide for the details), connection module item K8001 must not be installed. The additional power supply (space required 2 modules) can only be installed in the electrified frame or together with 1 or 2 actuators, depending on the size of the box.

INSTALLATION EXAMPLE OF THE DIGITAL CONTROLS

Installation with flush-mounted actuator

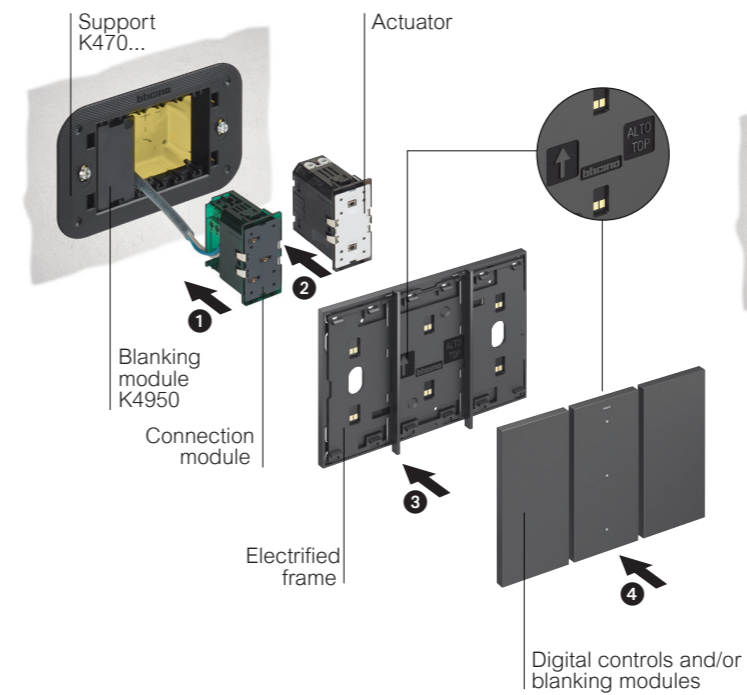

Use in conjunction with the connection module, or another actuator, to take up the power voltage.

Installation with actuator in DIN switchboard

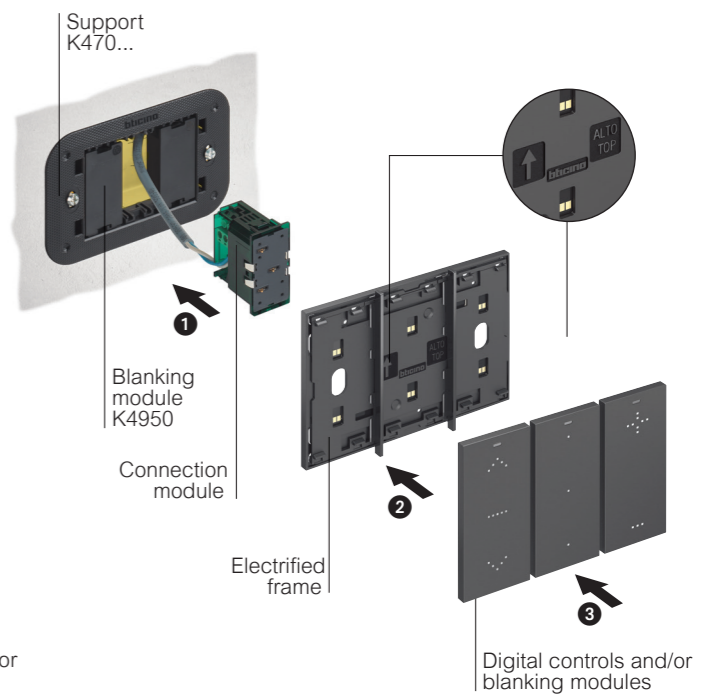

At the side of the connection module, install 2 false poles, item K4950, in any position.

Installation of the voice control

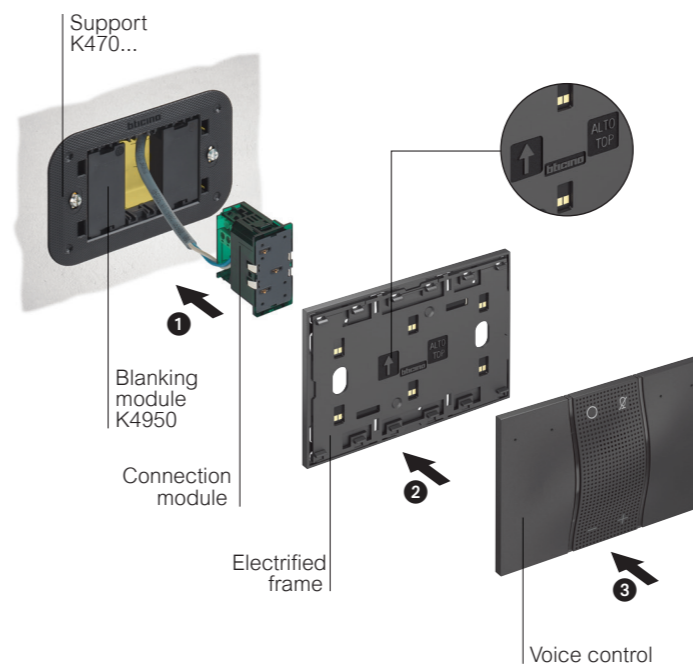

Remove the finishing bars from the electrified frame. When installing power supply item K8003, connection module item K8001 must not be used.



**Living Now**  
how to install the covers

**LIGHT POINT INSTALLATION**

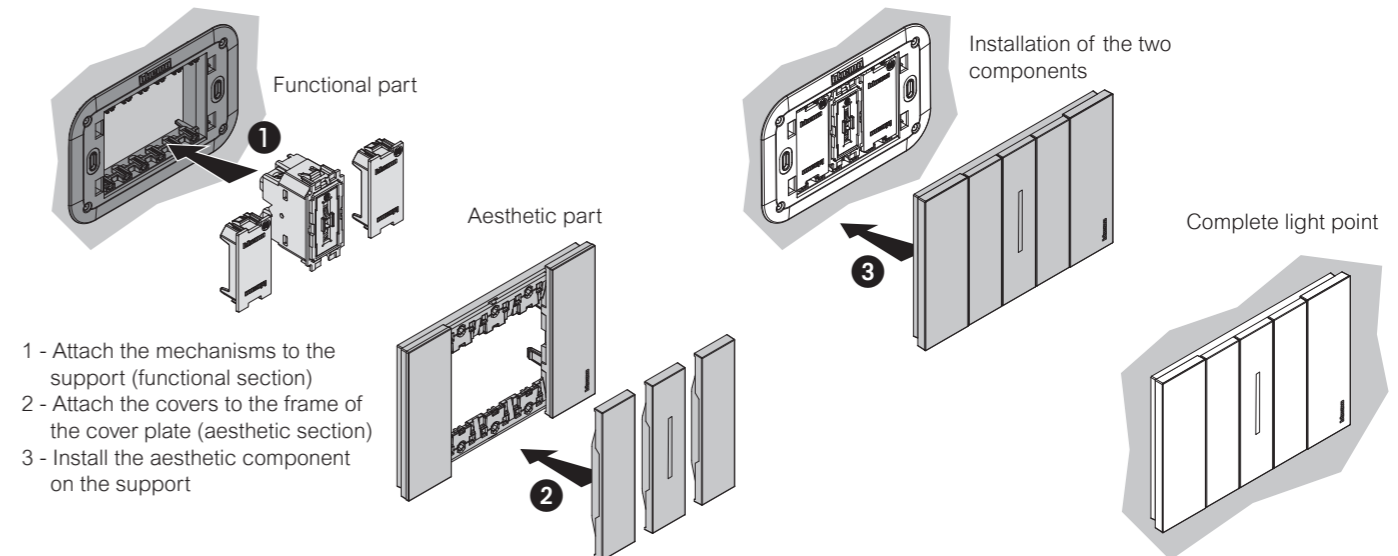

**REMOVING MOBILE COVERS**

**!** Mobile covers are those that move in relation to the light point, to allow the activation of a control (traditional, connected or MyHOME\_Up)

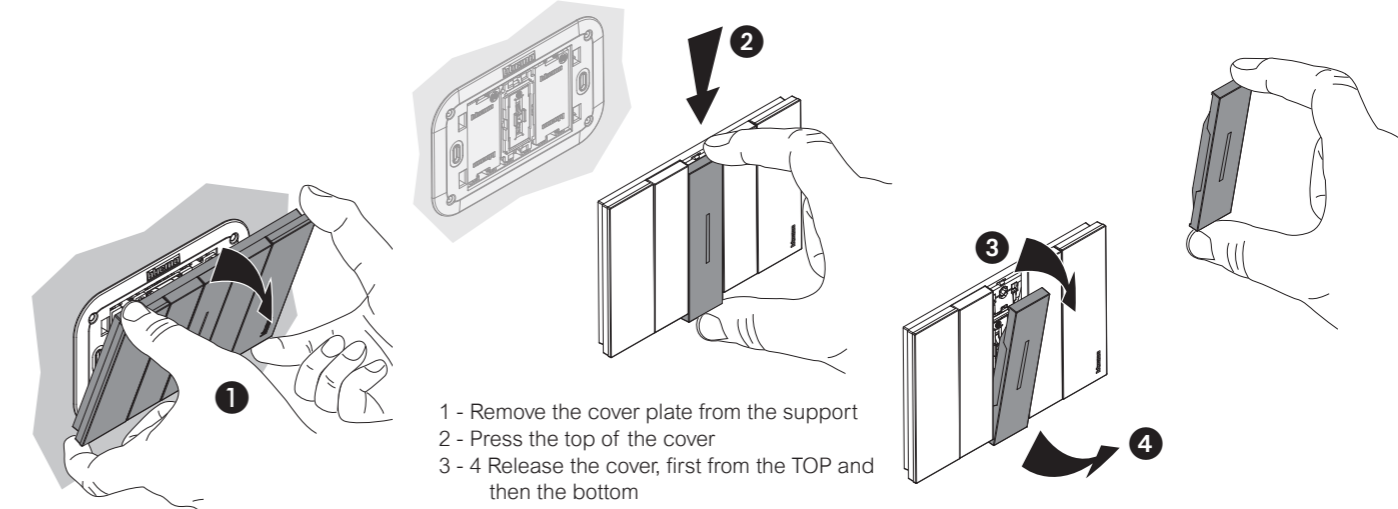

**REMOVING FIXED COVERS**

**!** Fixed covers those are attached to the cover plates, such as for example blanking modules and all non-control devices (e.g. sockets, RJ connectors, TV sockets, USB chargers, etc.)

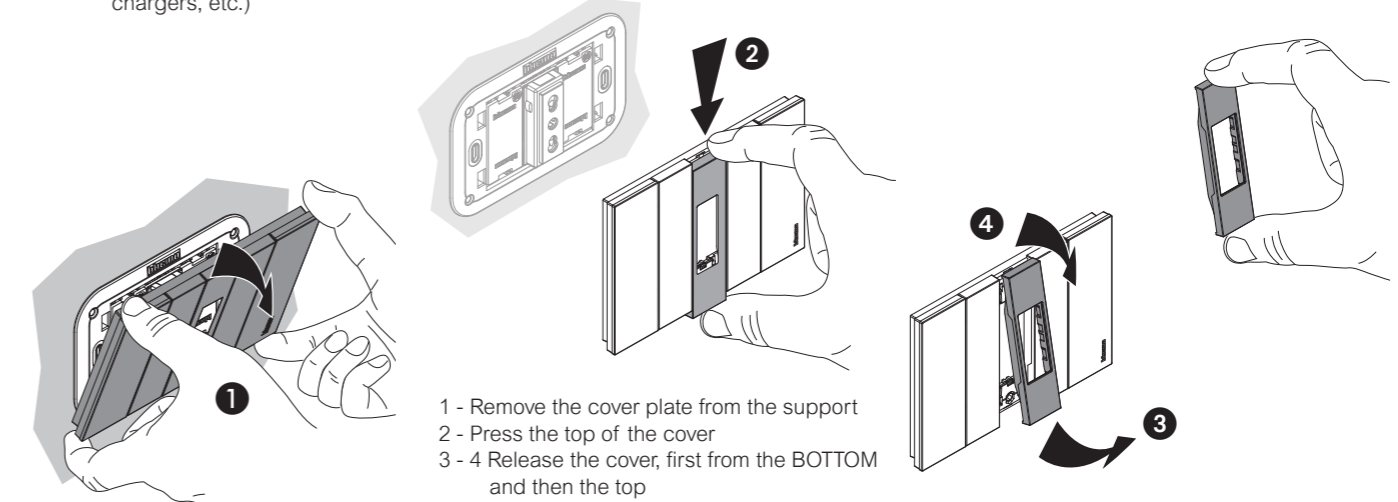

Living Now



TECHNICAL INFORMATION,  
DIMENSIONAL DATA

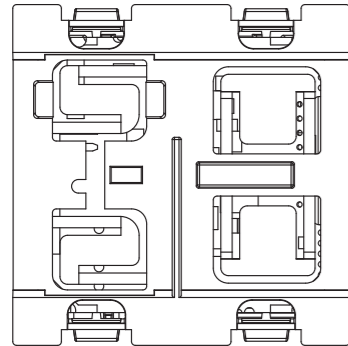

K4410  
K4411

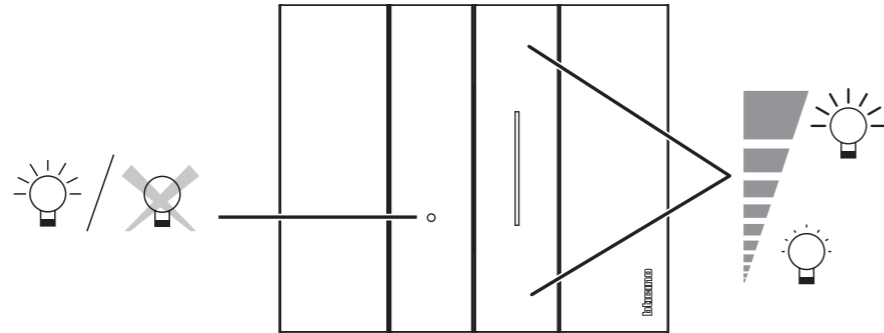

Switch the light on and off and bring the light to the desired level with a simple soft touch.  
Possibility of setting different brightness levels.  
ON/OFF notification LED.

DIMMER ITEM K4410 - TABLE OF MANAGED LOADS

		1-10 V		
240 V ~ 50/60 Hz	Min.	20 VA	20 VA	20 VA

DIMMER ITEM K4411 - TABLE OF MANAGED LOADS

		R		L		C/L			
240 V ~ 50/60 Hz	Min.	3 W	3 W	3 VA	3 VA	3 VA	3 VA	3 W	3 W

IR SENSOR ITEM K4430 - TABLE OF MANAGED LOADS

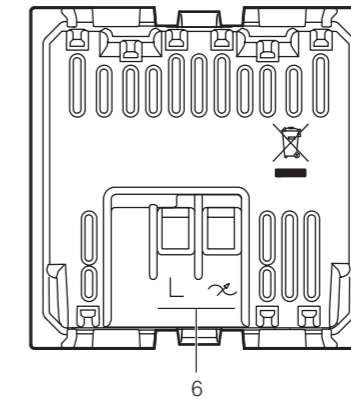
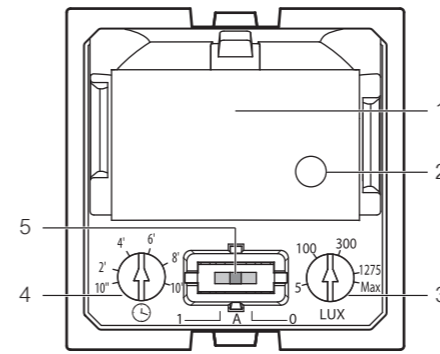

- PIR sensor
- Lighting sensor
- Brightness adjustment from 5 lux to 1275 lux  
Max: Test mode
- Timing adjustment from 10 sec.\* to 10 min.
- ON - AUTO - OFF switch  
1: forced switching ON  
A: ON/OFF auto  
0: forced switching OFF
- Connection clamps

Table of managed loads

 	Filament lamp or halogen lamp		LED lamp		Fluorescent compact		Electronic transformer		Ferromagnetic transformer	
	240 V ~ 50/60 Hz	Max. 250 W Min. 3 W	1 A 0.02 A	Max. 100 W Min. 3 W	0.4 A 0.02 A	Max. 100 W Min. 3 W	0.4 A 0.02 A	Max. 250 W Min. 3 W	1 A 0.02 A	Max. 250 W Min. 3 W

IR SENSOR ITEM K4432 - TABLE OF MANAGED LOADS

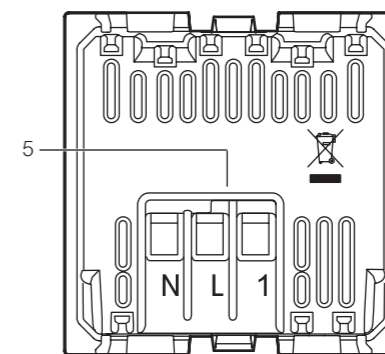
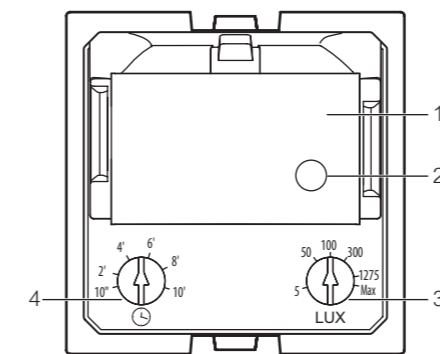

- PIR sensor
  - Lighting sensor
  - Brightness adjustment from 5 lux to 1275 lux\*  
Max: Test mode
  - Timing adjustment from 10 sec.\* to 10 min.
  - Connection clamps
- \* Factory settings

Table of managed loads

 	Filament lamp or halogen lamp		LED lamp		Fluorescent compact		Electronic transformer		Ferromagnetic transformer	
	240 V ~ 50/60 Hz	400 W	1.8 A	200 VA	0.8 A	200 VA	0.8 A	200 VA	0.8 A	200 VA



IR SENSOR ITEM K4431 - TABLE OF MANAGED LOADS

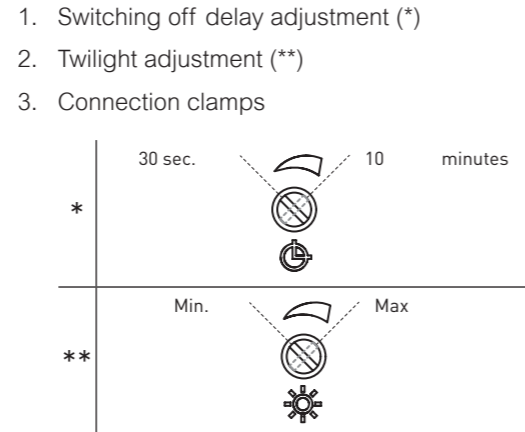
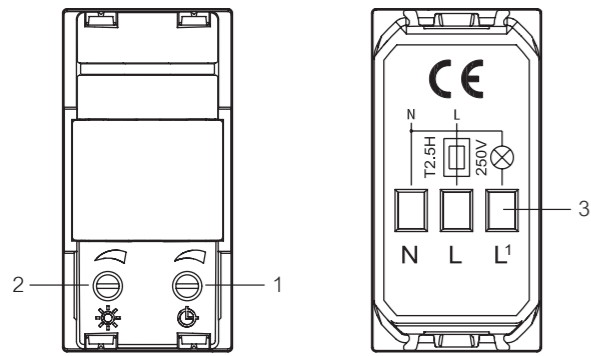
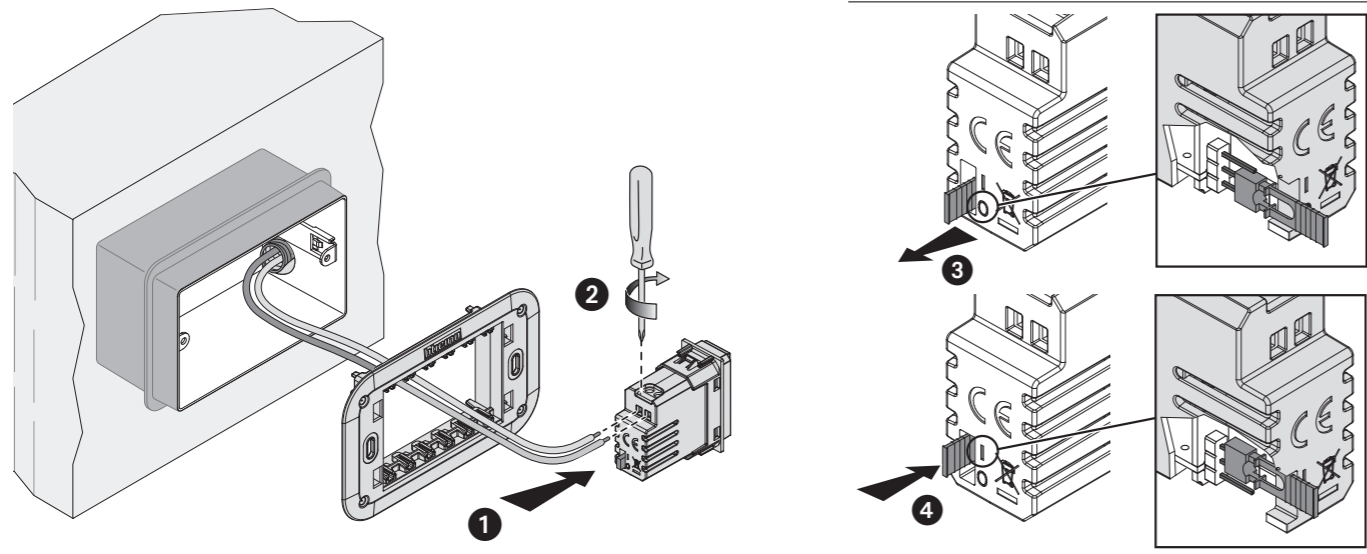

Table of managed loads

+45°C +5°C	2x2,5mm <sup>2</sup>					
Loads	Filament lamp or halogen lamp	Electronic transformer	Fluorescent tube	Fluorescent compact or LED lamp	Motor (cosφ=0,5)	
240 V ~ 50/60 Hz	460 W 2 A	460 W 2 A	460 W 2 A	50 W 0.5 A	30 W 2 A cosφ=0.5	

LED SAFETY LAMP< ITEM K4381 - AUTOMATIC OPERATION MODE SELECTION



Technical features

Power supply	230 Va.c. , 50/60Hz
Consumption	2.5 VA (0.1 W)
Non-replaceable rechargeable battery	NiMH 3.6 V 140 mAh
Charging time	48 hours
Autonomy	2 hours
Maximum cable section	1 x 1.5 mm <sup>2</sup>
Light intensity	2400 mcd
Angle of emission	120°
Not pull-out	

ELECTRONIC ROOM THERMOSTAT ITEM KW4441-KG4441-KM4441

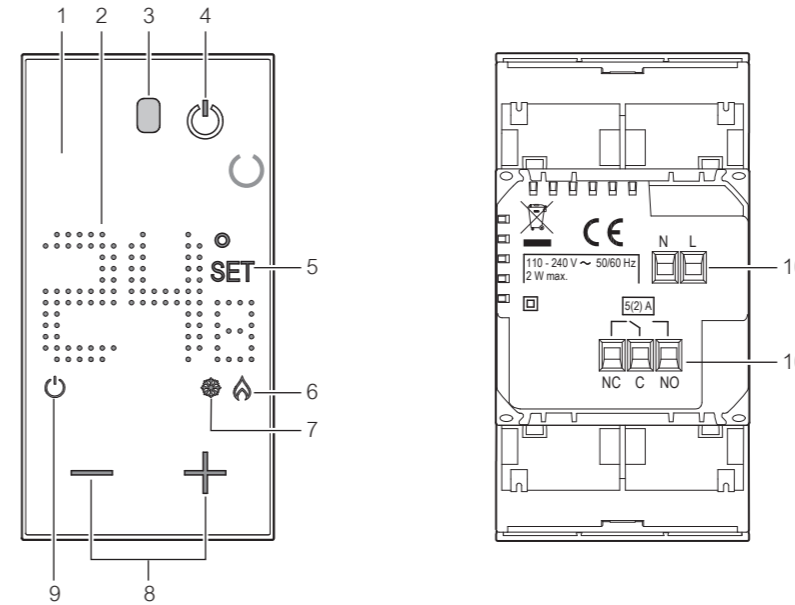

1. Backlit display
2. Temperature display
3. Lighting sensor
4. ON / OFF key sets the system (OFF) in anti-frost (7 °C) or heat-protection (35 °C) mode
5. Temperature setting indicator: appears when the temperature is being set
6. ON heating indicator
7. ON cooling indicator
8. Keys for temperature setting
9. OFF thermostat indicator
10. Connection clamps

Wiring diagrams

- System only for heating with clean contact (e.g. boiler activation) or heating and cooling with floor system

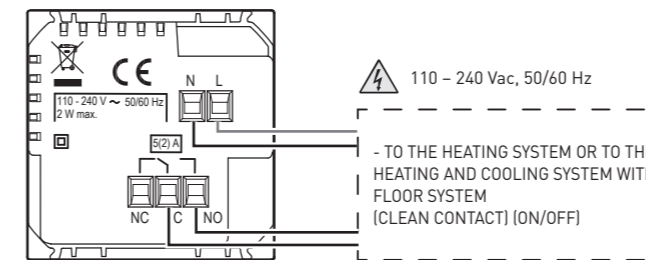

- Heating and cooling with different systems

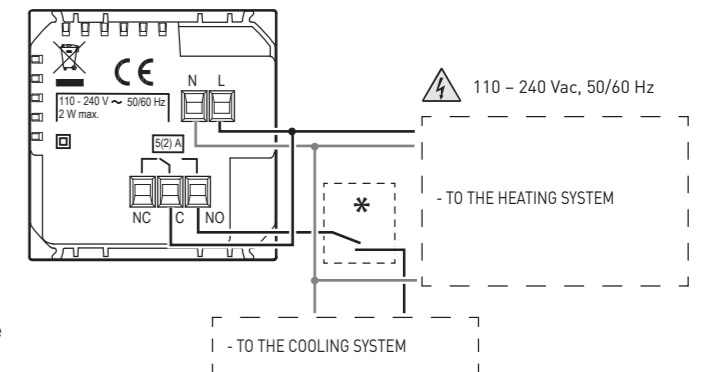

- System only for heating with load to be controlled to the mains voltage (e.g. 230Vac solenoid valve)

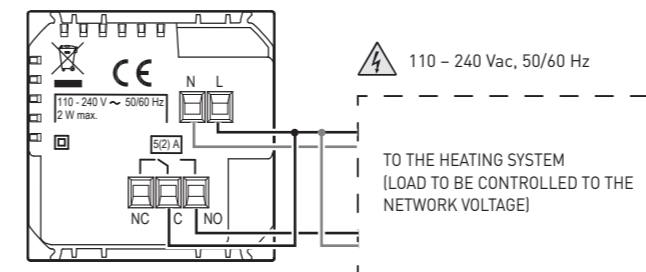

Technical features

Power supply	110 - 240 V~, 50/60 Hz
Absorption	2 W max
Maximum cable section	1 x 1.5mm <sup>2</sup>
Operating temperatures	5 - 40 °C
Setpoint temperature	5 - 40 °C; increase of 0.5 °C
Type of operation	1BU
Pollution index	2
Rated pulse voltage	4 kV
Contact output	5(2) A

Technical features for all devices

Technology: ZigBee certified product, Zigbee 3.0 public profile  
 Performance: 200 m range in a free point-to-point field  
 Band frequency: from 2.4 to 2.4835 GHz

Connected TWO-WAY SWITCH ITEM K4003C

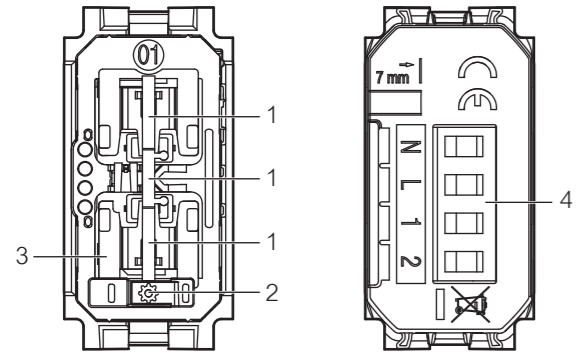

- 1 - Control pushbutton
- 2 - Setting pushbutton
- 3 - Notification LED
  - red steady: device not in Zigbee network
  - green steady: device in Zigbee network
- 4 - Connection clamps

Wiring diagram - interrupted

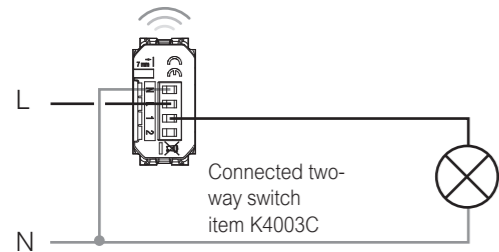

Wiring diagram - redirected or inverted

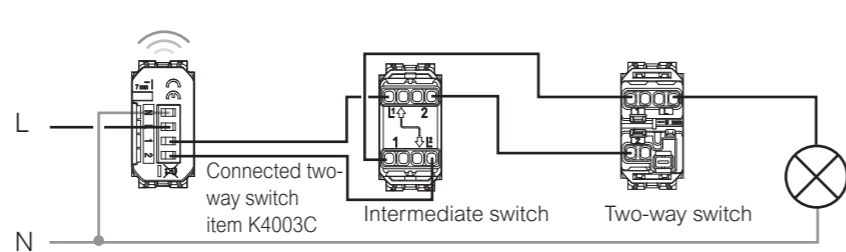
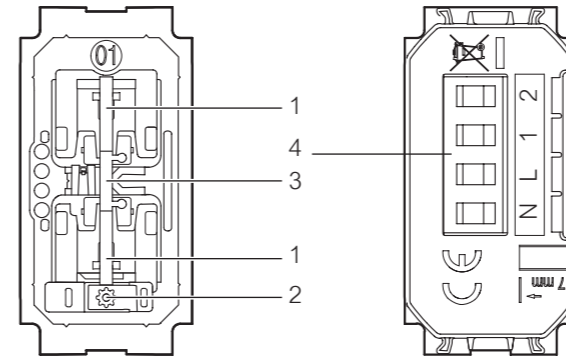

Table of managed loads

Temperature: +45°C / +5°C Terminal area: 2 x 2,5mm²	Filament lamp or halogen lamp	LED lamp	Fluorescent compact	Electronic transformer	Ferromagnetic transformer
Loads	Filament lamp or halogen lamp	LED lamp	Fluorescent compact	Electronic transformer	Ferromagnetic transformer
240 V~ 50/60 Hz	250 W	50 W	125 VA	125 VA	125 VA
Technology	ZigBee certified product, Zigbee 3.0 public profile				
Performances	200 m range in a free point-to-point field.				
Power level	REC 70-03: <20dBm				
Band frequency	from 2,4 to 2,4835 GHz				

DIMMER ITEM K/L/N/NT4411C



- 1 - Control pushbutton
- 2 - Reset pushbutton
- 3 - Notification LED
- 4 - Connection clamps

Basic diagram

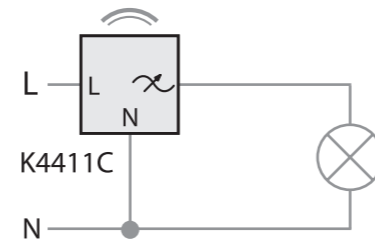
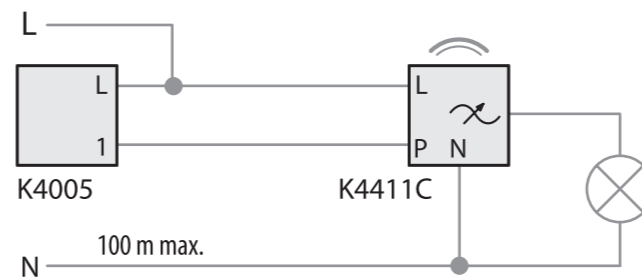

Diagram with remote control pushbuttons



Technical features

Temperature: +45°C / +5°C Terminal area: 1 X 1,5 mm²	Filament lamp or halogen lamp	LED lamp
Loads	Filament lamp or halogen lamp	LED lamp
240 VAC	150 W	150 W
100 VAC	75 W	75 W
Technology	Radio (Wireless meshed network)	
Power level	< 100 mW	
Band frequency	from 2,4 to 2,4835 GHz	

SHUTTERS CONTROL ITEM K4027C

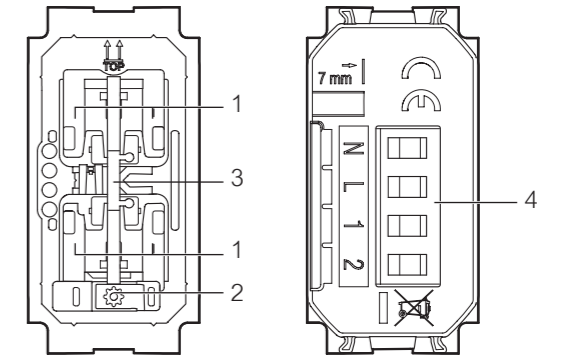

- 1 - Control pushbutton
- 2 - Reset pushbutton
- 3 - Notification LED
- 4 - Connection clamps

Wiring diagram - interrupted

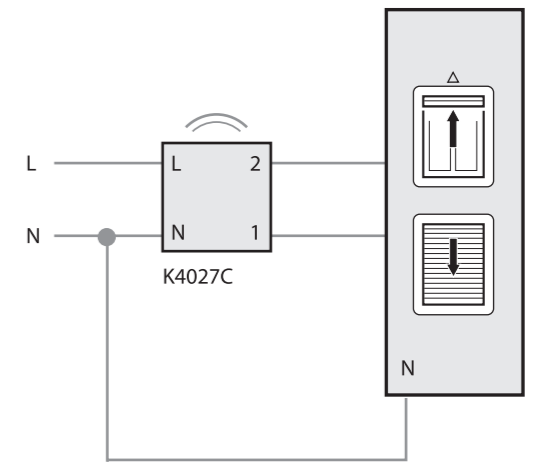

Warning: only compatible with standard motors (no pulse motors, no radio motors)

Technical features

Temperature: +45°C / +5°C Terminal area: 1 X 1,5 mm²	Motor for shutters
Loads	Motor for shutters
240 VAC max.	1 x 500 VA
100 VAC max.	1 x 270 VA
Technology	Radio (Wireless meshed network)
Power level	< 100 mW
Band frequency	from 2,4 to 2,4835 GHz



CONNECTED LIGHT RELAY ITEM 3584C

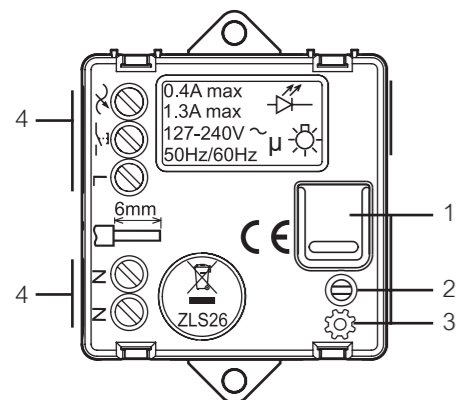

- 1 - Control pushbutton
- 2 - Setting pushbutton
- 3 - Notification LED
  - red steady: device not in Zigbee network
  - green steady: device in Zigbee network
- 4 - Connection clamps

Wiring diagram

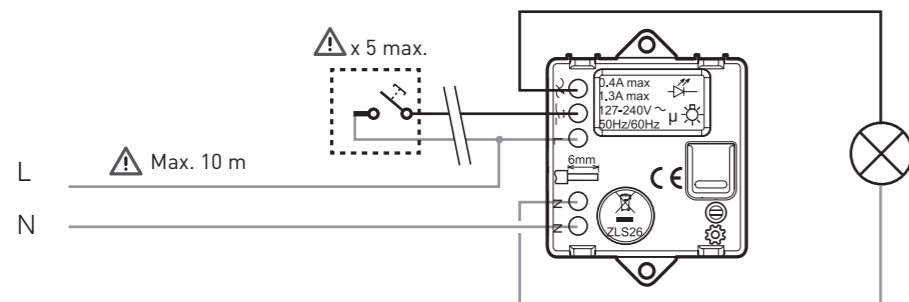

Option: remote control through mechanical pushbutton, not luminous.

Table of managed loads

	R	L			
Loads	Filament lamp or halogen lamp	LED lamp	Fluorescent compact	Electronic transformer	Ferromagnetic transformer
240 V ~ 50/60 Hz    Max.	300 W	(*) 100 W	250 VA	250 VA	250 VA

\* or 10 maxi. lamps

\*\* warning: ferromagnetic transformers must be charged at over 60% of their rated power.

CONNECTED MODULE FOR SOCKET ITEM K4531C

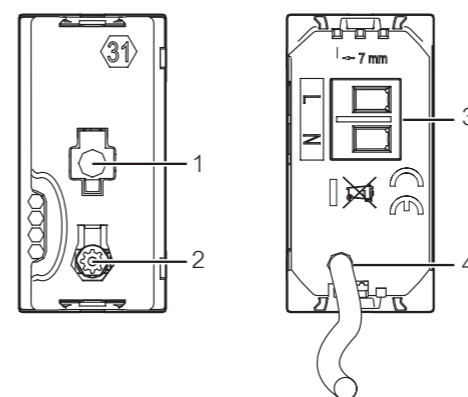

- 1 - notification LED
  - red steady: device not in Zigbee network
  - green steady: device in Zigbee network
- 2 - Setting pushbutton
- 3 - Connection clamps
- 4 - load controlled phase cable

Wiring diagram

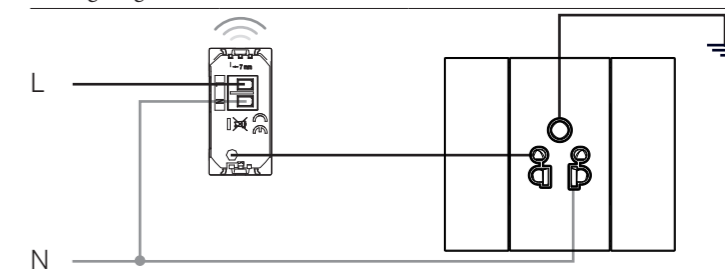
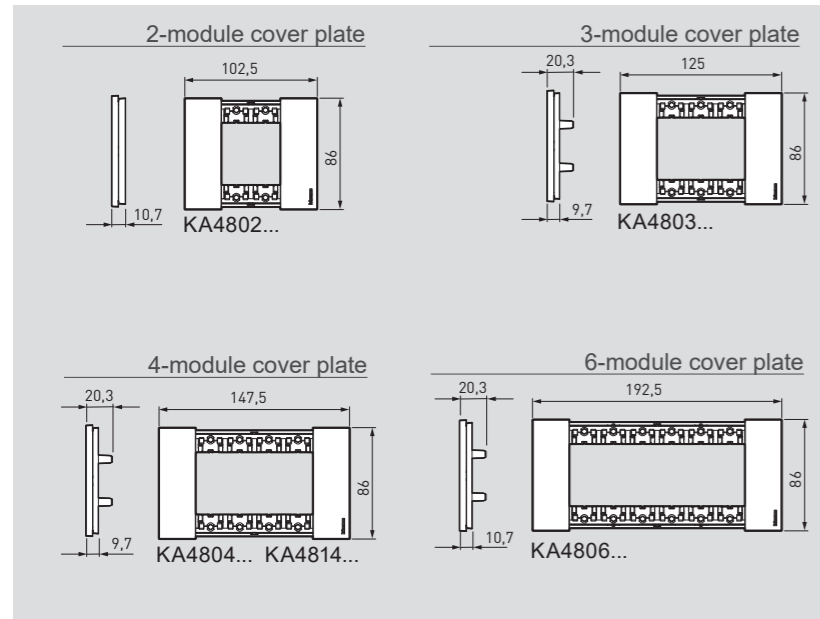

Table of managed loads

Loads	Filament lamp	Halogen lamp	Electronic transformer	Ferromagnetic transformer	Fluorescent tube	Fluorescent compact	LED lamp	Ventilation motor
230 Va.c. 3800 W cos 0,8	16 A							

Living Now cover plates (3 module area system)



Living Now supports (3 module area system)

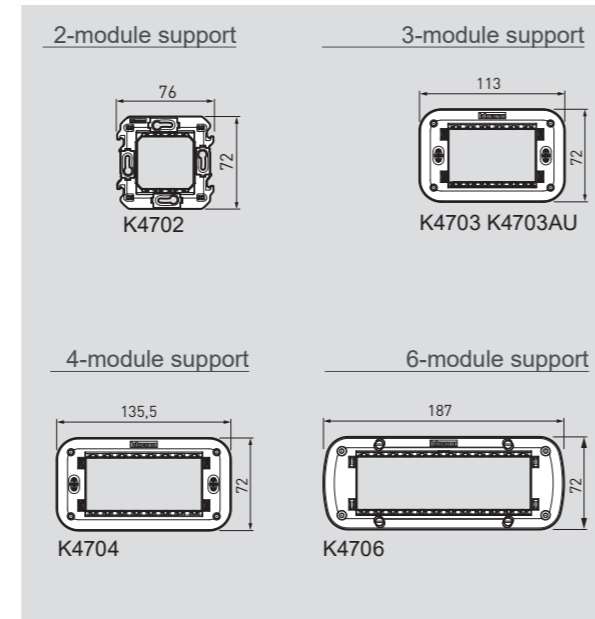

Living Now MyHOME\_Up electrified frames

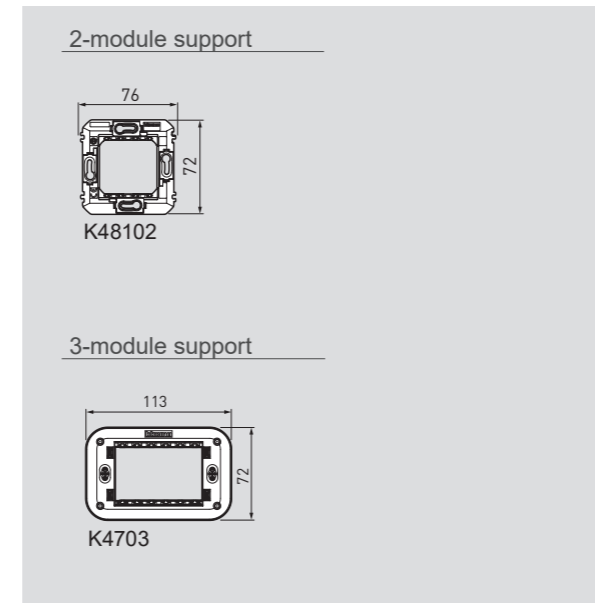
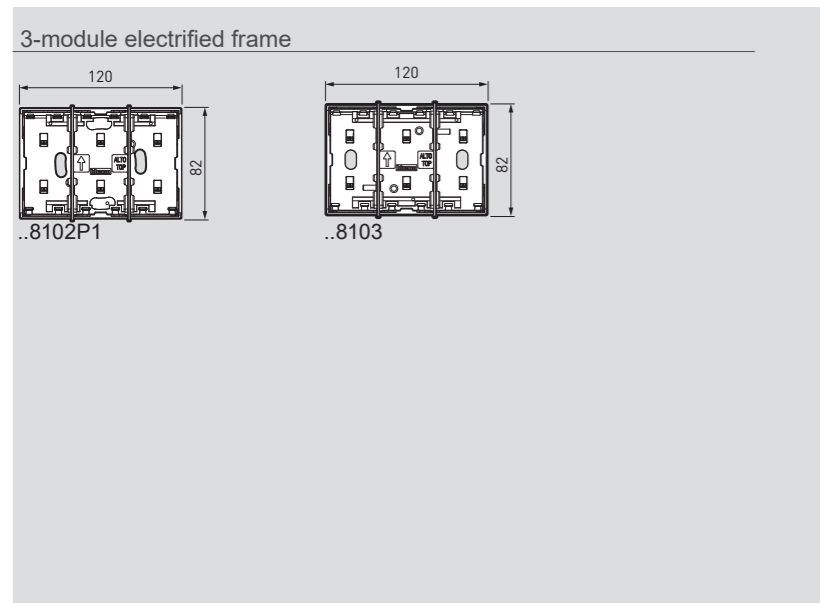

Smarter Thermostat

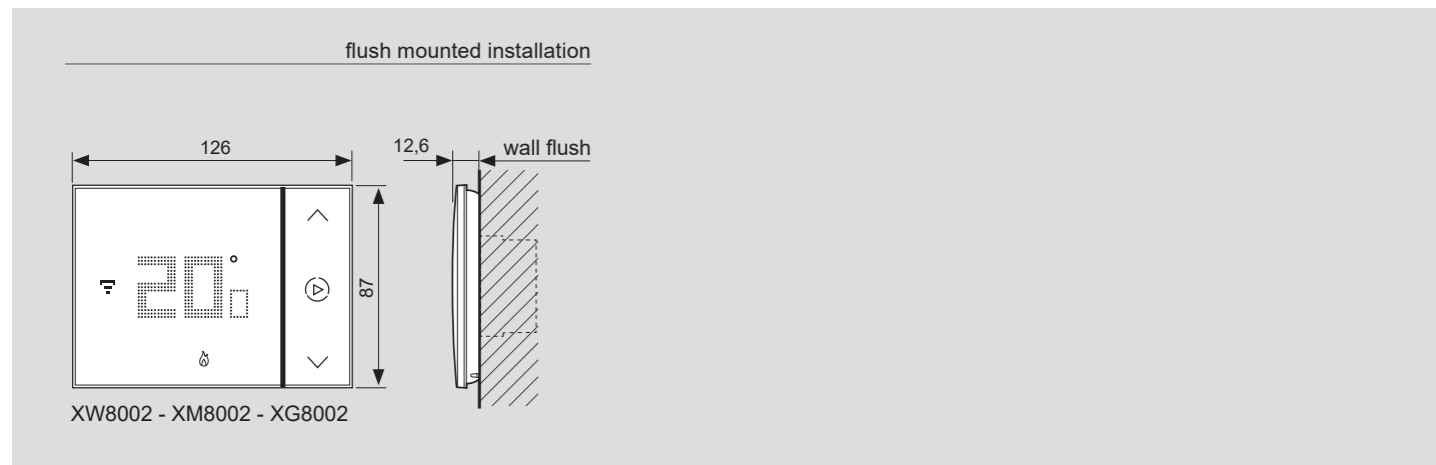



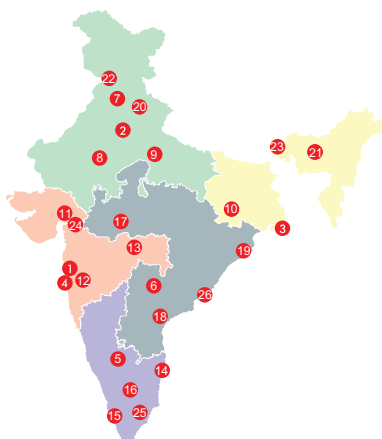

## Branch offices

7. Unit 203, 2nd Floor, Tower- B, Bestech Business Tower, Sector 66, Mohali, **CHANDIGARH**-160066.  
Telefax : (0141) 2208665, 666 **INNOVAL**
8. 507-510, 5th Floor, Soni Paris Point, Jai Singh Highway, Banipark, **JAIPUR**- 302 016.  
Tel / Fax : (0141) 220 8665 / 666
9. 209-A, 2nd Floor, Cyber Heights, Opp. Indira Gandhi Pratishthan, Vibhuti Khand, Gomti Nagar **LUCKNOW**- 226 010.  
Tel : (0522) 431 9316 **INNOVAL**
10. 202 & 203, 2nd Floor, Sunrise, Forum 100, Burdwan Compound, Lalpur, **RANCHI** - 834 001.
11. A 101-102, Mondeal Heights, Besides Novotel Hotel, Sarkhej Gandhinagar Highway (S G Highway), **AHMEDABAD** - 380 015.  
Tel : (079) 6134 0555 **INNOVAL**
12. 402, Swastik Chambers, Near Ashwamegh Marriage Hall, Behind HP Petrol Pump, Off Karve Road, Erandwane, **PUNE** - 411 004.  
Tel : (020) 6729 5601 / 602  
Fax : (020) 6729 5604
13. Plot No.95, II Floor, Shreyash Heights, VIP Road, Ramdaspath, **NAGPUR** - 440 010.  
Tel : (0712) 662 7857 / 858  
Fax : (0712) 662 7859
14. 10 B, (10th Floor), Prestige Center Court Office Block Vijaya Forum Mall, #183, N.S.K. Salai, Vadapalani **CHENNAI** - 600 026.  
Tel : (044) 6612 2800 / 2362 3125 / 35 / 45  
Fax : (044) 2362 3165 **INNOVAL**
15. J. B. Manjooran Estate, Door No 50/1107A9, 3rd Floor, Bye Pass Junction, Edappally, **COCHIN** - 682 024.  
Tel : (0484) 280 1921 / 2921, 658 0921 **INNOVAL**
16. B-5, 1st Floor, Thirumalai Towers, 723, Avanashi Road, **COIMBATORE** - 641 018.  
Tel : (0422) 222 3634 / 668 3200 **INNOVAL**
17. 204-205, Megapolis Square, 579, M G Road, **INDORE** - 452 001.  
Tel : (0731) 4999 891 / 892
18. MF-2, Datta's Lords House, Jamma Chettu Street, Mogalrajapuram, **VIJAYAWADA** - 520 010.  
Tel : (0866) 248 2393/6393/5393
19. Plot No. 359, Saheed Nagar, 2nd Floor, **BHUBANESWAR** - 751 007.  
Tel : (0674) 254 0623
20. Unit - 1 & 2, Vijay Park, Main Chakrata Road, **DEHRADUN**- 248 001. Uttarakhand.  
Tel : (0135) 661 6100 **INNOVAL**
21. House No. 97, Ground Floor, Rajgarh Main Road, Opp. City Heart Nursing Home, **GUWAHATI** - 781 007.  
Tel : (0361) 245 8498

## Head offices

1. 61 & 62, 6th Floor, Kalpataru Square, Kondivita Road, Off Andheri-Kurla Road, Andheri (E), **MUMBAI** - 400 059.  
Tel : (022) 3041 6200  
Fax : (022) 3041 6201  
Website : www.legrand.co.in

## Regional sales offices

2. A-25, Mohan Co-operative Industrial Estate, Mathura Road, **NEW DELHI** - 110 044.  
Tel : (011) 3990 2200, 2699 0046,  
(011) 2699 0028 / 29 / 30 / 31  
Fax : (011) 2699 0047
3. Bhakta Towers, 2nd & 3rd Floor, Plot No. KB 22, Sector-III, Saltlake, **KOLKATA** - 700 098.  
Tel : (033) 4021 3535 / 36  
Fax : (033) 4021 3537
4. C/203, Corporate Avenue, Atul Projects, Near Mirador Hotel, Chakala, Andheri Ghatkopar Link Road, Andheri - East, **MUMBAI** - 400 099.  
Tel : (022) 3385 6200 / 62301000 **INNOVAL**
5. Ferozes Manor, Situated at 58 Hospital Road, Shivaji Nagar, **BANGALORE**- 560 001.  
Tel : (080) 6822 0000 **INNOVAL**
6. 205-208, 2nd Floor, Block - II, White House, Kundan Bagh, Begumpet, **HYDER ABAD** - 500 016.  
Tel : (040) 2341 4398 / 67, 4567 1717  
Fax : (040) 6636 6974

## Area offices

22. Cabin No. 9, Second Floor, Madhok Trade Centre, Madhok Complex, Ferozpur Road, **LUDHIANA** - 141 001.  
Tel : (0161) 277 0301 / 2 / 3 / 4
23. 94, Udham Singh Sarani, Ground Floor, Ashrampara, **SILIGURI** - 734 001.  
Tel : (0353) 264 1067
24. A-207, Universal Business Center, Near Madhuvan circle, L.P. Savani Road, Adajan, **SURAT** - 395 009. **INNOVAL**
25. Aparna Towers, 1st Floor, 2/3, Bypass Road, **MADURAI** - 625 010.  
Telefax : (0452) 230 8414
26. 43-9-205, Near srikanya theatre 3rd floor, Plot No 10, Subbalaskhmi Nagar, Allipuram Ward, Dondapar thy Area, **VISHAKAPATHANAM** - 530 016.  
Tel : (0891) 273 5652 / 9363 **INNOVAL**



**EMB Electrical Industries S.A.E.**

## Headquarter office

Pyramids Heights Office Park  
KM 22 Cairo - Alex. desert road  
Building 1B, 12556  
Tel.: +202 3536 0000  
Fax: +202 3536 0001  
www.legrand.eg

f leggrand

@ leggrandegypt